



**YOUR JOURNEY;
OUR EXCELLENCE**

XYZ FASTENERS
Automotive Hardware Products
Wholesale

Contacts:

Himanshu Patel (Peter): 516-455-6331

Mike Patel: 917-435-2648

Office Fax# 631-648-9575

Email: XYZFastenersinc@gmail.com

Website: www.xyzfasteners.com



VALUE

SERVICE

QUALITY

FASTENERS

AVAILABILITY

YOUR JOURNEY
our excellence

1

2

3

4







Peter: 516-455-6331



Mike: 917-435-2648

Fax: 631- 648-9575

Email: XYZFastenersinc@gmail.com

www.xyzfasteners.com

<p>268</p> <p>SUBARU MOULDING RETAINER WITH SEALER</p> <div style="text-align: center;">  </div> <p>268 A 25 PCS 268 B 250 PCS 268 C 500 PCS</p>	<p>269</p> <p>FIAT, CITROEN & PEUGEOT MOULDING CLIP W/SEALER</p> <p>Body Side Material : Nylon Color : White Stem Diameter : 10.3MM Stem Length : 13MM Top Head Size : 11MM x 12MM Bottom Head Size : 15MM x 19MM OEM Number : (856543 ; 71728806 ; 71728806 ; 68093998AA)</p> <div style="text-align: center;">  </div> <p>269 A 25 PCS 269 B 250 PCS 269 C 500 PCS</p>	<p>270</p> <p>GM PUSH- TYPE RETAINER</p> <div style="text-align: center;">  </div> <p>Front Fender & Body Side Liner Head Diameter : 20MM Stem Length : 12MM Hole Size : 8.5MM Material : Nylon Color : Black OEM : (11612035)</p> <p>270 A 25 PCS 270 B 250 PCS 270 C 500 PCS</p>
<p>271</p> <p>Body Side & Wheel Opening Moulding Clip</p> <div style="text-align: center;">  </div> <p>Material : Nylon Color : White Stem Diameter : 8 x 8MM Stem Length : 8MM Top Head Size : 10 x 10.5MM Bottom Head Diameter : 15MM OEM : (9046708224 ; 9046708224)</p> <p>271 A 25 PCS 271 B 250 PCS 271 C 500 PCS</p>	<p>272</p> <p>Rocker Moulding & Mud Guard Push-Type Retainer</p> <div style="text-align: center;">  </div> <p>Head Diameter : 20MM Stem Length : 21MM Hole Size : 10MM Material : Nylon Color : Black OEM: (90501SDR003 ; 90501SDR003)</p> <p>272 A 25 PCS 272 B 250 PCS 272 C 500 PCS</p>	<p>273</p> <p>Door Trim Applique Clip</p> <div style="text-align: center;">  </div> <p>Material : Nylon Color : White Type : Clip Stem Diameter : 4.4mm x 7mm Stem Length : 8mm Top Head Diameter : 10mm Bottom Head Diameter : 10mm Overall Height : 12.5mm OEM Number : (11602522)</p> <p>273 A 25 PCS 273 B 250 PCS 273 C 500 PCS</p>
<p>274</p> <p>TOYOTA MOULDING CLIP WITH SEALER OEM: 90467-08225</p> <div style="text-align: center;">  </div> <p>274 A 25 PCS 274 B 250 PCS 274C 500 PCS</p>		

<p>260</p> <p>INFINITI</p> <p>Door & Interior Trim Panel Retainer</p> <p>Material : Nylon</p> <p>Color : Green</p> <p>Stem Length : 15MM</p> <p>Top Head Diameter : 13MM</p> <p>Middle Head Diameter : 16.4MM</p> <p>Bottom Head Diameter : 18MM</p> <p>OEM Number : (0155310641)</p> <p>260 A 15 PCS</p> <p>260 B 250 PCS</p> <p>260 C 500 PCS</p>	<div style="text-align: center;">  </div> <p>261</p> <p>ACURA/HONDA</p> <p>Rocker, Pillars Garnish & Exterior Trim</p> <p>Type : Push-Type Retainer with Sealer</p> <p>Head Diameter : 20MM</p> <p>Stem Length : 13MM</p> <p>Hole Size : 8.5MM</p> <p>Material : Nylon</p> <p>261 A 15 PCS</p> <p>261 B 250 PCS</p> <p>261 C 500 PCS</p>
<p>262</p> <p>ACURA/HONDA</p> <p>PUSH-TYPE RETAINER WITH SEALER</p> <p>OEM</p> <p>Garnish & Rear Spoiler</p> <p>Head Diameter : 20MM</p> <p>Stem Length : 13MM</p> <p>Hole Size : 8.5MM</p> <p>Material : Nylon</p> <p>Color : Black</p> <p>(91512STKA01 ; 91512STKA01)</p> <p>262 A 10 PCS</p> <p>262 B 250 PCS</p> <p>262 C 500 PCS</p>	<div style="text-align: center;">  </div> <p>263</p> <p>GM RETAINER-</p> <p>Door Trim Panel Retainer</p> <p>Type : Double Head</p> <p>Bottom Head Diameter : 17MM</p> <p>Top Head Diameter : 13MM</p> <p>Stem Length : 14MM</p> <p>Stem Diameter : 9MM</p> <p>Material : Nylon</p> <p>Color : Gray</p> <p>OEM: (11547574 ; 11611822 ; 11610605)</p> <p>263 A 25 PCS</p> <p>263 B 250 PCS</p> <p>263 C 500 PCS</p>

264

GM RETAINER

Door Trim Panel Retainer

Type : Double Head

Bottom Head Diameter

: 17MM

Top Head Diameter : 15MM

Stem Length : 14MM

Stem Diameter : 9MM

Material : Nylon

Color : Yellow

OEM Number : (11610606)

264A 25 PCS

264 B 250 PCS

264 C 500 PCS



265

LAND ROVER MOULDING

Wheel Arch

Material : Nylon

Color : Blue

Type : Moulding

Retainer

Stem Diameter : 10MM

Stem Length : 16MM

Top Head Diameter : 14MM

Middle Head Diameter : 15.5MM

Bottom Head Diameter : 18MM

OEM Number : (LR027255)

265A 15 PCS

265 B 250 PCS

265 C 500 PCS



266

TOYOTA/LEXUS RETAINER WITH SEALER

Rocker & Quarter Vent

Moulding Clip with Sealer

Type : Moulding Clip

Bottom Head Diameter : 15MM

Stem Length : 11MM

Stem Diameter : 8MM x 8MM

Material : Nylon

Color : Yellow

Top Head Size : 8MM x 8MM

Includes : Sealer

OEM Number : (6295550010 ; 6295550010)

266A 25 PCS

266 B 250 PCS

266 C 500 PCS



267

TOYOTA

Lower Door Moulding
Retainer with Sealer

Bottom Head Diameter : 15MM

Top Head Diameter : 10MM

Stem Length : 10MM

Stem Diameter : 8.3MM x 8.3MM

Material : Nylon

Color : White

Includes : Sealer

OEM Number : (90467A0032)

267A 25 PCS

267 B 250 PCS

267 C 500 PCS



<p>458</p> <p>HYUNDAI/KIA MOULDING</p> <p>Fender, Body Side & Rocker Moulding Clip with Sealer</p> <p>Material : Nylon Color : White Type : Moulding Clip Stem Length : 11MM Top Head Size : 10MM x 12MM Bottom Head Size : 14MM x 20MM Includes : Sealer OEM : (877162W000 ; 877162W000)</p> <p>458 A 50 PCS 458 B 250 PCS 458 C 500 PCS</p>	<p>459</p> <p>FORD MOULDING CLIP</p>  <p>Rocker Panel Ground Effects Moulding Clip</p> <p>Material : Nylon Color : Black Stem Length : 14MM Head Size : 16 x 50MM Hole Size : 9MM Ford : 2004: Mustang 2003: Mustang 2002: Mustang 2001: Mustang 2000: Mustang 1999: OEM : (F4ZZ6310182A)</p> <p>459 A 15 PCS 459 B 250 PCS 459 C 500 PCS</p>
<p>460</p> <p>TOYOTA & LEXUS MOULDING CLIP</p> <p>Material : Nylon Color : White Type : Moulding Clip Length : 25MM Stem Length : 22MM Top Head Size : 13MM x 13MM OEM : (525350E030)</p> <p>460 A 15 PCS 460 B 250 PCS 460 C 500 PCS</p>	<p>461</p> <p>FORD MOULDING CLIP</p>  <p>Rocker Panel Moulding Clip</p> <p>Material : Nylon Color : Gray Top Head Size : 22 x 30MM Overall Length : 18MM OEM : (W716350S300 ; 6G1Z5410182A)</p> <p>461 A 15 PCS 461 B 250 PCS 461 C 500 PCS</p>

256

MAZDA

Bumper Cover & Fender Liner
Push-Type Retainer

Type : Push-Type Retainer

Head Diameter : 20MM

Stem Length : 14MM

Hole Size : 8MM

Material : Nylon

Color : Black

OEM Number : (BGV456145)



256 A 25 PCS
256 B 250 PCS
256 C 500 PCS

257

TOYOTA

Fender Liner Push-Type
Retainer

Material : Nylon

Color : Black

Type : Push-Type Retainer

Stem Length : 10MM

Head Diameter : 20MM

Hole Size : 7MM

OEM Number : (9046707215)



257 A 25 PCS
257 B 250 PCS
257 C 500 PCS

258

GM
MOULDING CLIP
WITH SEALER

Body Side & Exterior
Trim Moulding Clip with
Sealer

Material : Nylon

Color : White

Type : Moulding Clip with Sealer

Stem Length : 11MM

Top Head Size : 12MM x 20MM

Bottom Head Diameter : 19MM

Hole Size : 9MM

Includes : Sealer

OEM Number : (11547581)



258 A 25 PCS
258 B 250 PCS
258 C 500 PCS

259

FORD
MOULDING
RETAINER
WITH SEALER

Body Side & Wheel
Opening

Material : Nylon

Color : White

Stem Length : 12MM

Top Head Diameter : 14.5MM

Middle Head Diameter : 15MM









Bottom Head Diameter : 14.5MM

OEM Number : (W716507S300)



259 A 15 PCS
259 B 250 PCS
259 C 500 PCS

XYZ FASTENERS

<p>627</p> <p>Trim Panel Retainer Type : Triple Head Color : Pink</p>  <p>627 A 15 PCS 627 B 250 PCS 627 C 500 PCS</p>	<p>2440</p> <p>Screw Grommet Screw Size : M6.3 Material : Nylon Stem Length : 16MM Color : White Head Diameter : 18MM Hole Size : 8 x 8MM</p>  <p>2440 A 50 PCS 2440 B 250 PCS 2440 C 500 PCS</p>	<p>2441</p> <p>Screw Grommet with Sealer Screw Size : M5.5 (#12) Material : Nylon Stem Length : 18MM Color : White Head Diameter : 20MM Includes : Sealer</p>  <p>2441 A 50 PCS 2441 B 250 PCS 2441 C 500 PCS</p>
<p>540</p> <p>Weatherstrip Material : Nylon Color : Yellow Type : Retainer Stem Diameter : 6.5MM Stem Length : 7MM Top Head Size : 5MM x 15MM Bottom Head Diameter : 7.5MM</p>  <p>540 A 25 PCS 540 B 250 PCS 540 C 500 PCS</p>	<p>541</p> <p>Weatherstrip Material : Nylon Color : White Type : Retainer Stem Diameter : 7MM Stem Length : 8.5MM Head Size : 5MM x 15MM Bottom Head Diameter : 6.5MM</p>  <p>541 A 25 PCS 541 B 250 PCS 541 C 500 PCS</p>	<p>542</p> <p>Hood Seal Retaining Clip Type : Clip Stem Length : 8MM Stem Diameter : 7MM Material : Nylon Color : Black Head Size : 5MM x 13MM</p>  <p>542 A 25 PCS 542 B 250 PCS 542 C 500 PCS</p>
<p>543</p> <p>Weatherstrip Retainer Type : Retainer Stem Length : 6MM Stem Diameter : 5.5MM Material : Nylon Color : Red Head Size : 5MM x 13MM</p>  <p>543 A 50 PCS 543 B 250 PCS 543 C 500 PCS</p>	<p>536</p> <p>Toyota Camry, Echo, MR2 & Sienna 1997 - On Fender Splash Shield Push-Type Retainer Head Dia: 20MM Stem Len: 10MM Fits 7MM Hole OEM: 90467-07164</p>  <p>536 A 10 PCS 536 B 250 PCS 536 C 500 PCS</p>	





Peter: 516-455-6331









Mike: 917-435-2648

Fax: 631- 648-9575



Email: XYZFastenersinc@gmail.com

www.xyzfasteners.com

<p>447</p>  <p>Rear Combination Lamp Guide Moulding Clip Material : Nylon Color : White Stem Length : 10.5MM Top Head Diameter : 13MM Bottom Head Diameter : 20MM Includes : Sealer OEM:(81496-60010)</p> <p>447 A 25 PCS 447 B 250 PCS 447 C 500 PCS</p>	<p>448</p>  <p>Rocker Panel Moulding Clip</p> <p>Material : Nylon Color : White Top Head Size : 18MM x 16MM Bottom Head Size : 22MM x 20MM Overall Height : 19MM Includes : Sealer OEM(91514-SAA-003)</p> <p>448 A 15 PCS 448 B 250 PCS 448 C 500 PCS</p>	<p>449</p>  <p>Fender Flare & Rocker Moulding Clip Material : Nylon Color : Black Stem Length : 14MM Top Head Size : 14 x 38MM Bottom Head Size : 16 x 38MM Includes : 10MM</p> <p>449 A 15 PCS 449 B 250 PCS 449 C 500 PCS</p>
<p>179</p>  <p>Upper Grille Push- Type Retainer Type : Push-Type with Open End Head Diameter : 9MM Stem Length : 7MM Hole Size : 4MM Color : Black (90913003)</p> <p>179 A 25 PCS 179 B 250 PCS 179 C 500 PCS</p>	<p>180</p>  <p>TOYOTA LEXUS RETAINER Body Side Retainer</p> <p>Color : Red Stem Length : 24MM Head Diameter : 20MM Overall Length : 26MM Includes : Phillips Drive</p> <p>180 A 25 PCS 180 B 250 PCS 180 C 500 PCS</p>	<p>399</p>  <p>Rear Hatch Door Side Garnish & Front Body Pillar Garnish Moulding Clip Material : Nylon Color : White Overall Height : 14MM</p> <p>399 A 25 PCS 399 B 250 PCS 399 C 500 PCS</p>

<p>452 HONDA Lower Door</p>  <p>OEM# 75316-TP6-A01</p> <p>452 A 25 PCS 452 B 250 PCS 452 C 500 PCS</p>	<p>453 HONDA MOULDING CLIP</p>  <p>Description : Lower Outer Door Weatherstrip Material : Nylon Color : White OEM#75319-S9A-004</p> <p>453 A 15 PCS 453 B 250 PCS 453 C 500 PCS</p>	<p>454 NISSAN MOULDING CLIP WITH SEALER</p>  <p>Stem Length : 7MM Top Head Size : 6MM x 9MM Bottom Head Diameter : 13MM Hole Size : 8MM OEM#76882-EW008</p> <p>454 A 10 PCS 454 B 250 PCS 454 C 500 PCS</p>
<p>455 Door Moulding Clip</p>  <p>Material : Nylon Color : Blue Stem Length : 10MM Top Head Size : 14 x 18MM Bottom Head Size : 16 x 20MM Includes : Sealer OEM Number : (87756D3000)</p> <p>455 A 25 PCS 455 B 250 PCS 455 C 500 PCS</p>	<p>456 Wheel Opening & Rocker</p>  <p>Material : Nylon Color : White Type : Moulding Clip Stem Length : 14MM Top Head Size : 12MM x 20MM Bottom Head Size : 12MM x 20MM Hole Size : 9MM OEM Number : (W716351S300)</p> <p>456 A 25 PCS 456 B 250 PCS 456 C 500 PCS</p>	<p>457 Rocker Panel & Door</p>  <p>Material : Nylon Color : White Type : Moulding Clip with Sealer Stem Length : 14MM Top Head Size : 12MM x 20MM Bottom Head Size : 12MM x 20MM Hole Size : 9MM OEM Number : (W716352S300)</p> <p>457 A 25 PCS 457 B 250 PCS 457 C 500 PCS</p>
<p>253</p>  <p>Radiator Support Access Cover, Air Deflector & Side Shield Push-Type Retainer Head Diameter : 19MM Stem Length : 9MM Hole Size : 7MM Material : Nylon Color : Black</p> <p>253 A 25 PCS 253 B 250 PCS 253 C 500 PCS</p>	<p>254 CHRYSLER HOOD INSULATION RETAINER</p>  <p>OEM#4878883AA</p> <p>254 A 25 PCS 254 B 250 PCS 254 C 500 PCS</p>	<p>255 TOYOTA & MAZDA</p>  <p>PUSH TYPE RETAINER Bumper , Engine Cover, Fender & Quarter Panel OEM#B45A-56-146A,90118-WB048</p> <p>255 25 PCS 255 250 PCS 255 C 500 PCS</p>

XYZ FASTENERS

<p>2450 LEXUS/TOYOTA</p> <p>REAR BUMPER SIDE</p>  <p>BRACKET SCREW GROMMET</p> <p>SCREW SIZE : M6.3 (#14) STEM LENGTH : 19MM HEAD SIZE : 16MM X 18MM OEM: (5219722020 ; 5219722020)</p> <p>2450 A 15 PCS 2450 B 250 PCS 2450 C 500 PCS</p>	<p>2451</p> <p>NISSAN/INFINITI</p>  <p>Screw Grommet w/Sealer</p> <p>Screw Size: 2.9MM Material : Nylon Stem Length : 16MM Color : White Head Diameter : 12MM Hole Size : 7MM x 7MM Square OEM : (0128101121 ; 0128101121)</p> <p>2451 A 10 PCS 2451 B 250 PCS 2451 C 500 PCS</p>	<p>2452</p> <p>HYUNDAI SCREW</p>  <p>Bumper Cover Screw Grommet with Sealer</p> <p>Screw Size : M4.8 (#10) Stem Length : 18MM Color : White Bottom Head Diameter : 18MM Head Size : 14MM x 18MM OEM : (866251E000 ; 866253S000)</p> <p>2452 A 25 PCS 2452 B 250 PCS 2452 C 500 PCS</p>
<p>2440</p> <p>Screw Grommet</p> <p>Screw Size : M6.3 Material : Nylon Stem Length : 16MM Color : White Head Diameter : 18MM Hole Size : 8 x 8MM</p>  <p>2440 A 50 PCS 2440 B 250 PCS 2440 C 500 PCS</p>	<p>2441</p> <p>Screw Grommet with Sealer</p> <p>Screw Size : M5.5 (#12) Material : Nylon Stem Length : 18MM Color : White Head Diameter : 20MM Includes : Sealer</p>  <p>2441 A 50 PCS 2441 B 250 PCS 2441 C 500 PCS</p>	<p>450</p> <p>Bumper & Grille Retainer</p> <p>Length : 30MM Width : 13MM Material : Stainless Steel</p>  <p>OEM : (8659324000 ; 8659324000)</p> <p>450 A 25 PCS 450 B 250 PCS 450 C 500 PCS</p>
<p>462</p> <p>HYUNDAI/KIA ROCKER MOULDING</p> <p>tem Length : 10mm Top Head Size : 6mm x 18mm Bottom Head Size : 18mm x 32mm Overall Length : 16mm Stem Size : 9mm x 13.5mm OEM: (87758-G2000, 87767-J9000)</p>  <p>462 A 15 PCS 462 B 250 PCS 462 C 500 PCS</p>	<p>463</p> <p>HONDA Wheel Well Arch Protective Liner Moulding Clip with Sealer</p> <p>Material : Nylon Color : Black Type : Moulding Clip Stem Length : 11.5MM Top Head Size : 10MM x 10MM Bottom Head Size : 10MM x 19MM OEM: (91513T0AA01)</p>  <p>463 A 25 PCS 463 B 250 PCS 463C 500 PCS</p>	<p>464</p> <p>TOYOTA/LEXUS MOULDING CLIP WITH SEALER</p> <p>Front Fender Color : Black Stem Length : 10MM Head Size : 20 x 30MM OEM: (5385712010 ; 5385712010)</p>  <p>464 A 15 PCS 464 B 250 PCS 464 C 500 PCS</p>

Peter: 516-455-6331











Mike: 917-435-2648

Fax: 631- 648-9575

Email: XYZFastenersinc@gmail.com

www.xyzfasteners.com

NEW RETAINERS

<p>2439</p> <p>TOYOTA HEADLAMP GROMMET WHITE NYLON</p>  <p>OEM#90189-05142</p> <p>2439 A 25 PCS 2439 B 250 PCS 2439 C 500 PCS</p>	<p>2442</p> <p>NYLON GRILLE NUT #8 OR #10 SCREW SIZE 1/2 HEAD</p>  <p>2442 A 25 PCS 2442 B 250 PCS 2442 C 500 PCS</p>	<p>2443</p> <p>LICENSE PLATE NUT NYLON – FORD</p>  <p>1/4 (#14)</p>  <p>2443 A 50 PCS 2443 B 250 PCS 2443 C 500 PCS</p>
<p>2444</p> <p>GM LICENSE PLATE NYLON NUT, OEM#1196781 Screw Size : 1/4-20</p>  <p>2443 A 50 PCS 2443 B 250 PCS 2443 C 500 PCS</p>	<p>2445</p> <p>HYUNDAI NYLON NUT Fender Apron Nut Screw Size : M4.8 OEN# 86848-22000</p>  <p>2445 A 25 PCS 2445 B 250 PCS 2445 C 500 PCS</p>	<p>2449</p> <p>Body Side Moulding Floor & Trunk Screw Grommet Screw Size: M4.8 Material : Nylon Color : Natural Includes : Seal #10 SCREW OEM: 12810003U</p>  <p>2446 A 15 PCS 2446 B 250 PCS 2446 C 500 PCS</p>
<p>2446</p> <p>NISSAN OEM# 88796-6P000 Screw Grommet w/Sealer Screw Size : M4.8 Material : Nylon Stem Length : 15MM Color : Natural</p>  <p>2446 A 15 PCS 2446 B 250 PCS 2446 C 500 PCS</p>	<p>2447</p> <p>OEM#003-990-0251 BMW &MERCEDES- BENZ MOULDING NUT Across Flats : 10MM Flange Diameter : 16MM Overall Height : 11MM</p>  <p>2447 A 25 PCS 2447 B 250 PCS 2447 C 500 PCS</p>	<p>2448</p> <p>HYUNDAI/KIA OEM#84145-26000 SPLASH SHIELD NYLON NUT Hex Size : 14MM Flange Diameter : 30MM Overall Height : 10MM</p>   <p>448 A 15 PCS 2448 B 250 PCS 2448 C 500 PCS</p>

Peter: 516-455-6331







Mike: 917-435-2648

Fax: 631- 648-9575







Email: XYZFastenersinc@gmail.com

www.xyzfasteners.com

NEW RETAINERS

<p>440</p> <p>Description :Tail Light Retainer</p> <p>Type : Triple Head</p> <p>Bottom Head Diameter : 18MM</p> <p>Top Head Diameter : 15MM</p> <p>Stem Length : 13MM</p> <p>Stem Diameter : 9MM</p> <p>Material : Nylon Color : Black</p>  <p>440A 15 PCS 440 B 250 PCS 440 C 500 PCS</p>	<p>2438</p> <p>(Nissan: Black Nylon Screw Grommet</p> <p>Head Diameter: 16mm</p> <p>Stem Length: 12mm</p> <p>Fits Into 8mm x 8mm Hole</p> <p>Nissan Murano & Rogue 2014 – On</p> <p>OEM: (76881-JG00A)</p>  <p>2438 15 PCS 2438 250 PCS 2438 500 PCS</p>	<p>395</p> <p>Front & Rear Spoiler</p> <p>Material : Nylon</p> <p>Color : White</p> <p>Type : Moulding Clip</p> <p>Stem Length : 24MM</p> <p>Head Size : 10MM x 20MM</p> <p>Overall Length : 27MM</p>  <p>395 A 25 PCS 395 B 250 PCS 395 C 500 PCS</p>
<p>396</p> <p>Description : Front & Rear Bumper Clip</p> <p>Stem Length : 25MM</p> <p>Material : Nylon</p> <p>Color : White</p>  <p>396 A 25 PCS 396 B 250 PCS 396 C 500 PCS</p>	<p>397</p> <p>Moulding Clip</p> <p>Material : Nylon</p> <p>Color : White</p> <p>Type : Moulding Clip</p> <p>Stem Length : 11MM</p> <p>Head Size : 11.5MM x 21MM</p> <p>Overall Height : 17MM</p>  <p>397 A 50 PCS 397 B 250 PCS 397C 500 PCS</p>	<p>398</p> <p>Bumper</p> <p>Material : Nylon</p> <p>Color : Yellow</p> <p>Type : Moulding Clip</p> <p>Stem Length : 15MM</p> <p>Head Size : 19MM x 24MM</p> <p>Overall Height : 40MM</p>  <p>398 A 15 PCS 398 B 250 PCS 398 C 500 PCS</p>

NEW RETAINERS 2018

<p>431 Front Bumper, Fender, Windshield Washer & Rocker Moulding Push-Type Retainer Head Diameter: 20mm Stem Length: 10mm Fits Into 8mm Hole Subaru B9 Tribeca, Baja, Forester, Impreza, Legacy & Outback 2012 - 1998 Subaru: 59122-FA010 Black Nylon</p>  <p>431 A 25 PCS 431 B 250 PCS 431 C 500 PCS</p>	<p>432 Push-Type Retainer Head Diameter: 16mm Stem Length: 13mm Fits Into 7mm Hole Subaru Baja, Impreza, Legacy & Outback 2012 - 2000 Subaru: 91085-TA030 Black Nylon</p>  <p>432 A 25 PCS 432 B 250 PCS 432 C 500 PCS</p>	<p>433 Front Bumper & Fender Push-Type Retainer Head Diameter: 20mm Stem Length: 15mm Fits Into 10mm Hole Subaru Forester, Impreza & Outback 2006 - 02 Subaru: 90913-0059 Black Nylon</p>  <p>433 A 25PCS 433 B 250 PCS 433 C 500 PCS</p>
<p>434 White Nylon Top Head Size: 10mm x 12mm Bottom Head Size: 14mm x 18mm Stem Length: 10mm Hyundai Accent, Kia Soul & Mitsubishi Outlander 2006 - On (Hyundai: 87758-35010)</p>  <p>433 A 15 PCS 433 B 250 PCS 433 C 500 PCS</p>	<p>435 Yellow Nylon Top Head Size: 12mm x 16mm Bottom Head Diameter: 16mm Hyundai Elantra 2006 - 01 (Hyundai: 87703-H1000)</p>  <p>435 A 25 PCS 435 B 250 PCS 435 C 500 PCS</p>	<p>436 Blue Nylon Top Head Size: 10mm x 12mm Bottom Head Size: 14mm x 20mm Hyundai Santa Fe 2013 - On Kia Sportage 2011 - On (Hyundai: 87756-1F000)</p>  <p>436 A 25 PCS 436 B 250 PCS 436 C 500 PCS</p>
<p>437 White Nylon Top Head Size: 16mm x 20mm Bottom Head Size: 14mm x 18mm Stem Diameter: 13mm Stem Length: 10mm Hyundai Azera, Tiburon & XG300/350 2011 - 01 (Hyundai: 87758-39000)</p>  <p>437 A 25 PCS 437 B 250 PCS 437 C 500 PCS</p>	<p>438 Front Bumper & Quarter Panel Push-Type Retainer Head Diameter: 20mm Stem Length: 9mm Fits Into 7mm Hole Impreza, Legacy, Outback & Tribeca 2011 - 2005 Subaru: 90914-0051</p>  <p>438 A 25 PCS 438 B 250 PCS 438 C 500 PCS</p>	<p>439 Description Color : Black Radiator Splash Shield Push-Type Retainer Type : Push-Type with Drive Pin Head Diameter : 20MM Stem Length : 9MM Hole Size : 7MM</p>  <p>439 A 25 PCS 439 B 250 PCS 439 C 500 PCS</p>

Peter: 516-455-6331

Mike: 917-435-2648

Fax: 631- 648-9575

Email: XYZFastenersinc@gmail.com

www.xyzfasteners.com

NEW RETAINERS

<p>423</p> <p>Head Diameter: 15mm & 16mm Mazda 2000 - On Trim Panel Retainers Nylon</p>  <p>423 A 10 PCS 423 B 250 PCS 423 C 500 PCS</p>	<p>424</p> <p>Head Diameter: 18mm Stem Length: 14mm Fits Into 8mm Hole Hyundai Elantra, Equus, Genesis, Santa Fe & Sonata and Kia Forte, K900, Optima, Sedona & Sorento 2013 – On (Hyundai: 86595-2T500, 14206-08250-B)</p>  <p>424 A 15 PCS 424 B 250 PCS 424 C 500 PCS</p>	<p>425</p> <p>Honda Civic 2012 - On 91560-SZW-003 Door Panel & Interior Trim Retainer Top Head Diameter: 13mm Middle Head Diameter: 16mm Bottom Head Diameter: 18mm Green Nylon</p>  <p>425 A 25 PCS 425 B 250 PCS 425 C 500 PCS</p>
<p>626</p> <p>GM Trucks 1988 - On Trim Panel Retainers</p>  <p>626 A 25 PCS 626 B 250 PCS 626 C 500 PCS</p>	<p>426</p> <p>Top Head Diameter: 16mm x 19mm Bottom Head Diameter: 20mm Stem Length: 12mm Fits Into 8mm Hole Infiniti G20, JX35, Q45 & QX60 and Frontier, Maxima, NV, Pathfinder, Sentra, Versa & Xterra 2002 - On Nissan: 01553-2DR9</p>  <p>426 A 15 PCS 426 B 250 PCS 426 C 500 PCS</p>	<p>427</p> <p>Small Head Diameter: 13mm Large Head Diameter: 18mm Stem Length: 12mm Toyota Scuff Plate Retainers W. Nylon</p>  <p>427 A 15 PCS 427 B 250 PCS 427 C 500 PCS</p>
<p>428</p> <p>White Nylon Top Head diameter: 15mm Middle Head Diameter: 16mm Bottom Head Diameter: 18mm Hyundai & Kia 1995 - On (Hyundai: 82315-33020)</p>  <p>428 A 50 PCS 428 B 250 PCS 428 C 500 PCS</p>	<p>429</p> <p>Trim Panel Retainer Top Head Diameter: 13mm Middle Head Diameter: 16mm Bottom Head Diameter: 16mm Chevrolet Aveo 2004-On Hyundai Accent, Santa Fe, Sonata Tiburon & XG300/350 1999-On and Kia Optima, Rio & Sorento 2001-On</p>  <p>429 A 50 PCS 429 B 250 PCS 429 C 500 PCS</p>	<p>430</p> <p>White Nylon Top Head Size: 6mm x 12mm Bottom Head Diameter: 16mm Stem Length: 10mm Infiniti Qx80 2014 - On Nissan Juke 2011 - On (Nissan: 76882-JG10A)</p>  <p>430 A 25 PCS 430 B 250 PCS 430 C 500 PCS</p>

Peter: 516-455-6331

Mike: 917-435-2648

Fax: 631- 648-9575

Email: XYZFastenersinc@gmail.com

www.xyzfasteners.com

XYZ FASTENERS

NEW RETAINERS

386

Black Nylon Rocker Panel & Scuff Plate Retainer Lexus ES300 & ES330 2002 – On Toyota Avalon, Camry, Scion & Solara 2004 – On (75867-AA010)



386 A 15 PCS
386 B 250 PCS
386 C 500 PCS

387

(53888-48010) Black Nylon Wheel Opening Push-Type Retainer Head Diameter: 18mm Stem Length: 14mm Fits Into 7mm Hole Highlander 2001 – On



387 A 5 PCS
387 B 250 PCS
387 C 500 PCS

388

(90914-0051) Black Nylon Front Bumper & Quarter Panel Push-Type Retainer Head Diameter: 20mm Stem Length: 9mm Fits Into 7mm Hole B9 Tribeca, Impreza, Legacy & Outback 2005 – On



388 A 15 PCS
388 B 250 PCS
388 C 500 PCS

389

(46064-AE000) Black Nylon Front Fender Bumper & Quarter Panel Push-Type Retainer Head Diameter: 15mm Stem Length: 8mm Fits Into 7mm Hole Baja, Forester, Impreza, Legacy & Outback 2003 – On



389 A 10 PCS
389 B 250 PCS
389 C 500 PCS

390

Push-Type Retainer Head Diameter: 15mm Stem Length: 11mm Fits Into 6mm Hole Mitsubishi Endeavor, Galant, Lancer, Mirage, Montero & Outlander 1997 - On Mitsubishi: MR288150 Black Nylon



390 A 10 PCS
390 B 250 PCS
390 C 500 PCS

391

(01553-07111) Black Nylon Trim Panel Retainer Overall Length: 20.5mm Nissan Altima and Infiniti G35 & Q45 1997 – On



391 A 25 PCS
391 B 250 PCS
391 C 500 PCS

392

(000-990-57-92) Gray Nylon Door Panel Retaining Clip Mercedes-Benz



392 A 10 PCS
392 B 250 PCS
392 C 500 PCS

393

(90914-0055) Black Nylon Push-Type Retainer With Sealer Head Diameter: 25mm Shoulder Length: 3mm Shoulder Diameter: 16.5mm Stem Length: 12mm Fits Into 11mm Hole Subaru 2006 – On



393 A 5 PCS
393 B 250 PCS
393 C 500 PCS

394

(90914-0007) Black Nylon Bumper, Engine Cover, Fender & Grille Push-Type Retainer Head Diameter: 21mm Stem Length: 15mm Fits Into 10mm B9 Tribeca, Baja, Forester, Impreza, Legacy & Outback 2000 – On



394 A 15 PCS
394 B 250 PCS
394 C 500 PCS

Peter: 516-455-6331













Mike: 917-435-2648

Fax: 631- 648-9575

Email: XYZFastenersinc@gmail.com

www.xyzfasteners.com

FOREIGN RETAINERS

 <p>101 Toyota & Mazda Fits" 7mm Hole Push-Type Retainers O.E.M# 90467-06017</p> <p>101 A 25 PCS 101 B 250 PCS 101 C 500 PCS</p>	 <p>102 Head Diameter: 20mm Fits Into 7mm Hole Toyota 1994 – On Front Fender Liner O.E.M #:90467-07166</p> <p>102 A 25 PCS 102 B 250 PCS 102 C 500 PCS</p>	 <p>103 23/64" (9mm) Hole Size Flange: 15mm Stem: 16mm Bumper Cover Toyota # 90467-09145</p> <p>103 A 25 PCS 103 B 250 PCS 103 C 500 PCS</p>
<p>104 O.E.M #:11296-AG000 Front Bumper and Radiator Support Push-Type Retainer Head Dial: 20mm Stem Length: 13mm Fits Into 8mm Hole</p>  <p>104 A 20 PCS 104 B 250 PCS 104 C 500 PCS</p>	<p>105 Nissan # 91506-S9A-003 Bumper & Splash Shield Retainer with Metal Insert Head Diameter: 20mm Stem Length: 16mm Fits Into 10mm Hole Acura MDX, RDX</p>  <p>105 A 15 PCS 105 B 250 PCS 105 C 500 PCS</p>	<p>106 Nissan O.E.M# 01553-09611 Head Diameter: 18mm Stem Length: 12mm; Fits Into 8mm Hole Nissan 1994 - On</p>  <p>106 A 15 PCS 106 B 250 PCS 106 C 500 PCS</p>
<p>107 O.E.M #: Head Diameter: 20mm Fits 10mm Hole Acura3.5RL 1996-On</p>  <p>107 A 25 PCS 107 B 250 PCS 107 C 500 PCS</p>	<p>108 Honda 2006-On Head Dial: 20mm Stem Length: 13mm Fits Into 10mm Hole #91505-S9A-003</p>  <p>108 A 25 PCS 108 B 250 PCS 108 C 500 PCS</p>	<p>109 Head Dial: 20mm Stem Length: 13mm Fits Into 10mm Hole Honda 2006-On OEM #: 91505-S9A-003.</p>  <p>109 A 15 PCS 109 B 250 PCS 109 C 500 PCS</p>
<p>110 23/64" (9mm) Hole Size Flange: 18mm Stem: 31mm Black Nylon Bumper Cover & Grille Push Type Retainers Nissan # 63848-9E001</p>  <p>110 A 20 PCS 110 B 250 PCS 110 C 500 PCS</p>	<p>111 Toyota: 90467-10183 Head Dia: 18MM Stem Len: 7.5MM Fits Hole: 7MM GM: 88970767</p>  <p>111 A 15 PCS 111 B 250 PCS 111 C 500 PCS</p>	<p>112 O.E.M #:5216116010 Head Diameter: 18mm Stem Length: 28mm Fits 9mm Hole</p>  <p>112 A 15 PCS 112 B 250 PCS 112 C 500 PCS</p>

Peter: 516-455-6331

Mike: 917-435-2648

Fax: 631-648-9575

Email: XYZFastenersinc@gmail.com

www.xyzfasteners.com

FOREIGN RETAINERS			(Nylon Push Type)
<p>125 Toyota # 52161-20010 23/64" (9mm) Hole Size Flange: 18mm Stem: 31mm Cover & Grille</p>  <p>125 A 15 PCS 125 B 250 PCS 125 C 500 PCS</p>	<p>126 # 90467-09093 23/64" (9mm) Hole Size Flange Diameter: 15mm Stem Length: 27mm Bumper Cover</p>  <p>126 A 25 PCS 126 B 250 PCS 126 C 500 PCS</p>	<p>127 Lexus # 90467-09101 23/64" (9mm) Hole Size Flange: 18mm Stem: 23mm Black</p>  <p>127 A 15 PCS 127 B 250 PCS 127 C 500 PCS</p>	
<p>128 # 90467-07138 17/64" (7mm) Hole Size Flange Diameter: 20mm Stem Length: 12mm Black Nylon Push Type Retainers Lexus</p>  <p>128 A 25 PCS 128 B 250 PCS 128 C 500 PCS</p>	<p>129 Toyota # 90468-04030 Bright Zinc Finish Bumper Strip Retainers</p>  <p>129 A 25 PCS 129 B 250 PCS 129 C 500 PCS</p>	<p>130 Nissan # 80999-05N07 17/64" (7mm) Hole Size Flange Diameter: 18mm Stem Length: 16mm Black</p>  <p>130 A 25 PCS 130 B 250 PCS 130 C 500 PCS</p>	
<p>131 Nissan # 65846-30F00 3/16" (5mm) Hole Size Head Diameter: 30mm Stem Length: 9mm Black Nylon Hood Insulation Retainers</p>  <p>131 A 25 PCS 131 B 250 PCS 131 C 500 PCS</p>	<p>132 Toyota # 90467-09008 17/64"(7mm) Hole Size Head Diameter: 30mm Stem Length: 17mm</p>  <p>132 A 25 PCS 132 B 250 PCS 132 C 500 PCS</p>	<p>133 Toyota # 90467-09006 17/64" (7mm) Hole Size Head Diameter: 30mm Stem Length: 17mm Hood Insulation</p>  <p>133 A 25 PCS 133 B 250 PCS 133 C 500 PCS</p>	
<p>134 Toyota # 90467-09050 17/64" (7mm) Hole Size Head Diameter: 25mm Stem Length: 10mm Hood Insulation Retainers</p>  <p>134 A 15 PCS 134 B 250 PCS 134 C 500 PCS</p>	<p>135 Nissan # 01553-09321 5/16" (8mm) Hole Size Flange Diameter: 20mm Stem Length: 13mm Black</p>  <p>135 A 25 PCS 135 B 250 PCS 135 C 500 PCS</p>	<p>136 Honda #91501-S04-003 5/16" (8mm) Hole Size Flange: 20mm Stem: 10mm Front Fender</p>  <p>136 A 25 PCS 136 B 250 PCS 136 C 500 PCS</p>	

Peter: 516-455-6331













Mike: 917-435-2648

Fax: 631- 648-9575

Email: XYZFastenersinc@gmail.com

www.xyzfasteners.com

FOREIGN RETAINERS

<p>137 Lexus 1990 - On Head Diameter: 19mm Fits In 9Mm Hole #90467-09143</p>  <p>137 A 15 PCS 137 B 250 PCS 137 C 500 PCS</p>	<p>138 Acura #91501-SG0-003 7/16" (11mm) Hole Size Head Dia.: 9.5mm x 10mm Stem Length: 14mm</p>  <p>138 A 25 PCS 138 B 250 PCS 138 C 500 PCS</p>	<p>139 Honda #91534-SE0-000 5/16" (8mm) Hole Size Head Diameter: 8.5mm Stem Length: 11mm Whitee</p>  <p>139 A 25 PCS 139 B 250 PCS 139 C 500 PCS</p>
<p>140 Nissan #01553-06721 5/16" (8mm) Hole Size Flange: 20mm Stem: 15mm Black Nylon Front &</p>  <p>140 A 25 PCS 140 B 250 PCS 140 C 500 PCS</p>	<p>141 #90675-SB-003 Honda, Mazda, & Nissan Fits In 8mm Hole Head Diameter: 20mm</p>  <p>141 A 50 PCS 141 B 250 PCS 141C 500 PCS</p>	<p>142 Head Diameter: 20mm Push-Type Bumper Retainers Acura #91503-SPO- 003</p>  <p>142 A 25 PCS 142 B 250 PCS 142C 500 PCS</p>
<p>143 #62318-01W00 Nissan Grille Clips</p>  <p>143 A 15 PCS 143 B 250 PCS 143 C 500 PCS</p>	<p>144 Isuzu, Ford Escort Honda, Mitsubishi & Plymouth Laser Grille Clips</p>  <p>144 A 25 PCS 144 B 250 PCS 144 C 500 PCS</p>	<p>145 Toyota Grille Clips</p>  <p>145 A 25 PCS 145 B 250 PCS 145 C 500 PCS</p>
<p>146 Toyota Cressida #90467-17004 1984 - 1987 Radiator Grille</p>  <p>146 A 50 PCS 146 B 250 PCS 146 C 500 PCS</p>	<p>147 Nissan Head Diameter: 22mm Fits In 11mm Hole</p>  <p>147 A 25 PCS 147 B 250 PCS 147 C 500 PCS</p>	<p>148 Mazda & Nissan Flange Size: 20mm x30mm</p>  <p>148 A 25 PCS 148 B 250 PCS 148 C 500 PCS</p>













Peter: 516-455-6331

Mike: 917-435-2648

Fax: 631- 648-9575

Email: XYZFastenersinc@gmail.com

www.xyzfasteners.com

FOREIGN RETAINERS		
<p>149 Honda & Nissan Head Diameter: 15mm Fits" 6mm Hole</p>  <p>149 A 50 PCS 149 B 250 PCS 149 C 500 PCS</p>	<p>150 Hyundai # 81126-37010 5/16" (8mm) Hole Size Head Diameter: 26mm Stem Length: 14mm</p>  <p>150 A 15 PCS 150 B 250 PCS 150 C 500 PCS</p>	<p>151 9/32"(7.5mm) Hole Size Acura # 90700-SJ4-000 Head Diameter: 30mm Stem Length: 10mm Black Nylon Hood Insulation</p>  <p>151 A 25 PCS 151 B 250 PCS 151 C 500 PCS</p>
<p>152 25mm Width 34mm Length Black Nylon Front Fender & Bumper Cover Clips Use with # 20757 Toyota # 53879-58010</p>  <p>152 A 10 PCS 152 B 250 PCS 152 C 500 PCS</p>	<p>153 Head Diameter: 15mm Stem Length: 25mm Front Fender & Bumper Cover Pins Use with # 20758 Toyota # 47749-58010</p>  <p>153 A 15 PCS 153 B 250 PCS 153 C 500 PCS</p>	<p>154 Head Diameter: 15mm Stem Length: 15mm Fits In 6.3mm Hole Bmw 1984 - On</p>  <p>154 A 15 PCS 154 B 250 PCS 154 C 500 PCS</p>
<p>155 1/4" (6mm) Hole Size Flange Diameter: 18mm Stem Length: 11mm Black Nylon Vent Panel Blind Rivets Honda # 90688-SB0-003</p>  <p>155 A 25 PCS 155 B 250 PCS 155 C 500 PCS</p>	<p>156 11/32" (9mm) Hole Size Head Diameter: 17mm Stem Length:13mm Red Plastic Fender Moulding Clips Toyota # 90904-67037</p>  <p>156 A 25 PCS 156 B 250 PCS 156 C 500 PCS</p>	<p>157 Fender & Wheel Flare Toyota 2002 - On Moulding Clips</p>  <p>157 A 25 PCS 157 B 250 PCS 157 C 500 PCS</p>
<p>158 Head Diameter: 20mm Stem Length: 14mm Fits In 8.5mm Hole Mercedes Push-Type #201-990-02-92</p>  <p>158 A 25 PCS 158 B 250 PCS 158 C 500 PCS</p>	<p>159 Ford 1975 - On Hood Insulation Retainers</p>  <p>159 A 25 PCS 159 B 250 PCS 159 C 500 PCS</p>	<p>248 Head Diameter: 20mm Stem Length: 14mm; Fits In 10mm Hole Honda 2003-On Push-Type Retainers Nylon</p>  <p>248 A 15 PCS 248 B 250 PCS 248 C 500 PCS</p>













Peter: 516-455-6331

Mike: 917-435-2648

Fax: 631- 648-9575

Email: XYZFastenersinc@gmail.com



www.xyzfasteners.com

FOREIGN PUSH TYPE RETAINERS NYLON			
<p>335 GM; 1984 - On Head Diameter: 11/16 Fits Into 1/4 Hole Push Type Retainers</p>  <p>335 A 25 PCS 335 B 250 PCS 335 C 500 PCS</p>	<p>160 Honda Head Diameter 18mm Stem Length: 15mm; Fits 8mm Hole Push-Type Retainers Nylon</p>  <p>160 A 25 PCS 160 B 250 PCS 160 C 500 PCS</p>	<p>161 Head Diameter: 20mm Stem Length: 22mm; Fits Into 8mm Hole Nissan 1994 - On Push-Type Retainers Nylon</p>  <p>161 A 25 PCS 161 B 250 PCS 161 C 500 PCS</p>	
<p>162 CHRYSLER Head Size: 11/16" Stem Length: 13/16" Fits Into 1/4 Hole Push-Type Retainers</p>  <p>162 A 25 PCS 162 B 250 PCS 162 C 500 PCS</p>	<p>163 GM APV Vans Flange Outer Diameter: 21mm Fits Into 12mm Rear Bumper Fascia Retainers</p>  <p>163 A 25 PCS 163 B 250 PCS 163 C 500 PCS</p>	<p>164 GM Flange Diameter: 7/8 Fits Into 1/2" Hole Bumper Fascia Retainers</p>  <p>164 A 25 PCS 164 B 250 PCS 165 C 500 PCS</p>	
<p>165 Head Diameter: 7/8" Stem Length: 1" Fits In 1/4 Hole 1994 - On Push-Type Retainers</p>  <p>165 A 15 PCS 165 B 250 PCS 165 C 500 PCS</p>	<p>166 Cowl Vent Push-Type Retainer HD Dia: 8.5MM x 12MM Stem Len: 9MM Fits Into 5MM Hole Ford Fusion, Milan & Zephyr 2006-On Mazda 5 & 6 2003-On Ford: 3M8Z-1502316-A Mazda: GJ6E-50-715A</p>  <p>166 A 10 PCS 166 B 250 PCS 166 C 500 PCS</p>	<p>167 Head Size: 8mm x 17mm Fits In 7mm Hole; Toyota Cowl Panel Retainers Black Nylon</p>  <p>167 A 25 PCS 167 B 250 PCS 167 C 500 PCS</p>	
<p>336 Ford Facia Retainers Nylon</p>  <p>336 A 25 PCS 336 B 250 PCS 336 C 500 PCS</p>	<p>337 Ford & Chrysler Hood Insulation Radiator Grille Retainers Nylon</p>  <p>337 A 25 PCS 337 B 250 PCS 337 C 500 PCS</p>	<p>338 Head Diameter: 1" Panel Range: 1/4" Fits Into 3/8 Hole Gm 1982 - On</p>  <p>338 A 25 PCS 338 B 250 PCS 338 C 500 PCS</p>	

FOREIGN PUSH TYPE RETAINERS NYLON

<p>168 Bumper Cover Clip Width: 35mm Length: 25mm Use With 171 Lexus GS, IS & LS 2007 - On Lexus: 53879-50020</p>  <p>168 A 10 PCS 168 B 250 PCS 168 C 500 PCS</p>	<p>169 Nissan Sentra Wheel Housing And Fender Nylon U Nuts</p>  <p>169 A 10 PCS 169 B 250 PCS 169 C 500 PCS</p>	<p>170 Fender Push-Type Retainer Head Diameter: 20mm Stem Length: 10mm Fits Into 8mm Hole Honda Civic 2012 - On Honda: 91501-TR0-003</p>  <p>170 A 15 PCS 170 B 250 PCS 170 C 500 PCS</p>
<p>171 Bumper Cover Pin Retainer Head Diameter: 10mm Stem Length: 24mm Use With 168 Lexus GS, IS & LS 2007 - On Lexus: 47749-50090</p>  <p>171 A 15 PCS 171 B 250 PCS 171 C 500 PCS</p>	<p>172 Head Diameter: 30mm Stem Diameter: 15x20mm Acura & Honda 2000-On Hood Insulation Retainers</p>  <p>172 A 25 PCS 172 B 250 PCS 172 C 500 PCS</p>	<p>173 For 5mm Stud GM Air Intake Grille Panel Grommets</p>  <p>173 A 25 PCS 173 B 250 PCS 173 C 500 PCS</p>
<p>174 Bumper and Wheel Well Liner Push-Type Retainer Head Diameter: 20mm Stem Length: 14mm Fits Into 10mm Hole Acura ILX and Honda Insight 2012 - On Honda: 91505-TM8-003</p>  <p>174 A 15 PCS 174 B 250 PCS 174 C 500 PCS</p>	<p>175 Head Diameter: 20mm Stem Length: 21mm Fits In 9mm Hole; Gm 1999 - On Bumper Cover Retainers Black Nylon</p>  <p>175 A 25 PCS 175 B 250 PCS 175 C 500 PCS</p>	<p>176 Head Diameter: 20mm Stem Length: 28mm Fits 8mm Hole Trim Push-Type Retainers Blk Nylon</p>  <p>176 A 25 PCS 176 B 250 PCS 176 C 500 PCS</p>

FOREIGN RETAINERS PUSH NYLON

<p>200 Head Diameter: 20mm Stem Diameter: 8.5mm Stem Length: 20mm Dodge 300 Series, Magnum & Charger 2005-On Chrysler 4860379-AA</p>  <p>200 A 25 PCS 200 B 250 PCS 200 C 500 PCS</p>	<p>201 Head Diameter: 3/4" Stem Diameter: 11/32" Stem Length: 1-3/16" Gm 1993 - On</p>  <p>201 A 50 PCS 201 B 250 PCS 201 C 500 PCS</p>	<p>202 Head Diameter: 3/4" Stem Length: 7/8" Fits In 5/16 Hole Trim Panel</p>  <p>202 A 25 PCS 202 B 250 PCS 202 C 500 PCS</p>
--	--	---

Peter: 516-455-6331

Mike: 917-435-2648

Fax: 631- 648-9575













Email: XYZFastenersinc@gmail.com

www.xyzfasteners.com

FOREIGN RETAINERS PUSH NYLON

<p>203 Head Diameter: 3/4 Stem Length: 1-1/16 GM 1994 - On Wiring Harness & Headliner Retainers</p>  <p>203 A 50 PCS 203 B 250 PCS 203 C 500 PCS</p>	<p>204 Universal plastic clip Head Diameter: 11/16 Stem Length: 13/16; Stem Diameter: 5/16</p>  <p>204 A 100 PCS 204 B 250 PCS 204 C 500 PCS</p>	<p>205 GM Head Diameter: 11/16" Stem Length: 1-1/16 Stem Diameter: 5/16" Shield</p>  <p>205 A 50 PCS 205 B 250 PCS 205 C 500 PCS</p>
<p>206 Head Diameter 3/4" Stem Diameter: 11/32" Stem Length: 13/16" Chrysler Trim Panel</p>  <p>206 A 25 PCS 206 B 250 PCS 206 C 500 PCS</p>	<p>207 Head Diameter: 11/16" Stem Diameter: 5/16" Stem Length: 1-3/4; Ford 1997-On Mud Flap</p>  <p>207 A 25 PCS 207 B 250 PCS 207 C 500 PCS</p>	<p>208 Ford Explorer Head Diameter: 5/8" Stem Length: 3/4; Stem Diameter: 3/8"</p>  <p>208 A 50 PCS 208 B 250 PCS 208 C 500 PCS</p>
<p>209 GM; Head Diameter: 1 Stem Length: 13/16 Stem Diameter: 7/16"</p>  <p>209 A 30 PCS 209 B 250 PCS 209 C 500 PCS</p>	<p>210 Head Diameter: 22mm Stem Length: 28mm Stem Diameter: 11mm Fascia Retainers</p>  <p>210 A 25 PCS 210 B 250 PCS 210 C 500 PCS</p>	<p>211 Chrysler: 1985 - On Head Diameter: 25mm Stem Length: 20mm Stem Diameter: 7.5mm Fascia</p>  <p>211 A 25 PCS 211 B 250 PCS 211 C 500 PCS</p>
<p>212 Chrysler # 6502104 1/4" (6.4mm) Hole Size Panel Range: .070" - .805" Head: 1" Stem: 1 1/16"</p>  <p>212 A 25 PCS 212 B 250 PCS 212 C 500 PCS</p>	<p>213 1/4" (6.4mm) Hole Size Panel Range: .100" - .685" Head: 1" Stem: 1 3/32" Ford # 388930-S</p>  <p>213 A 50 PCS 213 B 250 PCS 213 C 500 PCS</p>	<p>214 1/4" (6.4mm) Hole Size Head Diameter: 1" Stem Length: 1 7/16" G.M. # 14027471</p>  <p>214 A 20 PCS 214 B 250 PCS 214 C 500 PCS</p>

RETAINERS

<p>215</p> <p>Head Diameter: 15/16 Stem Diameter: 3/8"; Stem Length: 3/4" Gm 2000-On</p>  <p>215 A 25 PCS 215 B 250 PCS 215 C 500 PCS</p>	<p>216</p> <p>Head Diameter: 1/2" Stem Length: 15/16" Stem Diameter: 1/4" Heat Shield Retainers Black Nylon</p>  <p>216 A 25 PCS 216 B 250 PCS 216 C 500 PCS</p>	<p>217</p> <p>Head Diameter: 25mm Stem Diameter: 9mm Ford 1995 - On Hood Insulation</p>  <p>217 A 25 PCS 217 B 250 PCS 217 C 500 PCS</p>
<p>218</p> <p>Ford Head Diameter: 1" Stem Diameter: 5/16"; Stem Length: 13/16 Bumper Fascia Retainers Black Nylon</p>  <p>218 A 25 PCS 218 B 250 PCS 218 C 500 PCS</p>	<p>219</p> <p>Head Diameter: 12mm Stem Diameter: 5mm Sq. Stem Length: 6mm Toyota 1998 - On Weather strip Retainers</p>  <p>219 A 25 PCS 219 B 250 PCS 219 C 500 PCS</p>	<p>220</p> <p>Honda Flange Diameter: 20mm Fits Into 8mm Hole Push-Type Retainers 91545-SE0-0030-W1; Nissan: 63848-01G00)</p>  <p>220 A 25 PCS 220 B 250 PCS 220 C 500 PCS</p>
<p>221</p> <p>GM Head Diameter 7/8" Stem Length 13/16 Stem Diameter 7/16" Front End Panel Retainers Nylon</p>  <p>221 A 25 PCS 221 B 250 PCS 221 C 500 PCS</p>	<p>222</p> <p>Head Diameter: 16mm Stem Length: 14mm Fits In 6mm Hole Bumper Cover Push-Type Retainers Nylon</p>  <p>222 A 15 PCS 222 B 250 PCS 222 C 500 PCS</p>	<p>223</p> <p>GM 1983 - On Head Diameter: 3/4" Stem Length 1-3/8"; Stem Diameter 5/16" Rear Hood Seal Retainers</p>  <p>223 A 25 PCS 223 B 250 PCS 223 C 500 PCS</p>
<p>224</p> <p>Bumper Cover Retainer Head Dia: 19MM Stem Dia 7.5MM Stem Len: 16MM Toyota, Lexus & Scion 1995 - On (90467-A0008)</p>  <p>224 A 50 PCS 224 B 250 PCS 224 C 500 PCS</p>	<p>225</p> <p>Head Diameter: 25mm Stem Diameter: 13mm; Stem Length: 15mm Gm Trucks 2002-On Fascia Retainers</p>  <p>225 A 25 PCS 225 B 250 PCS 225 C 500 PCS</p>	<p>226</p> <p>Cowl & Garnish Retainer Head Dia: 20MM Stem Dia: 7MM Stem Len: 15MM Honda Civic 2006 - On Black Nylon Honda: 91501-SEA-003</p>  <p>226 A 15 PCS 226 B 250 PCS 226 C 500 PCS</p>

Peter: 516-455-6331

Mike: 917-435-2648

Fax: 631- 648-9575

Email: XYZFastenersinc@gmail.com

www.xyzfasteners.com

RETAINERS		
<p>227 GM Head Diameter: 7/8" Stem Diameter: 7/16" Stem Length: 13/16 Shield Retainers Black Nylon</p> <p>227 A 50 PCS 227 B 250 PCS 227 C 500 PCS</p>	<p>228 Head Diameter: 22mm Stem Diameter: 7.5mm; Stem Length: 35mm Ford 2002 - On Retainers Nylon</p> <p>228 A 25 PCS 228 B 250 PCS 228 C 500 PCS</p>	<p>229 Head Diameter: 18mm Stem Diameter: 7mm; Fits Into 7mm Hole Toyota 2000 - On Push-Type Retainers Nylon</p> <p>229 A 15 PCS 229 B 250 PCS 229 C 500 PCS</p>
<p>230 Honda Head Diameter: 20mm Stem Length: 24mm Fits In 10Mm Hole Push-Type Retainers Nylon</p> <p>230 A 10 PCS 230 B 250 PCS 230 C 500 PCS</p>	<p>231 Cowl, Bumper & Fender Liner Push-Type Retainer Head Diameter: 20mm Stem Length: 12mm Fits Into 8mm Hole Infiniti FX35, FX45, G35 and Nissan 2003 - On Nissan: 01553-05323</p> <p>231 A 25 PCS 231 B 250 PCS 231 C 500 PCS</p>	<p>232 Nissan Sentra Head Diameter: 16mm Fits Into 8mm Hole Body Side Moulding Push-(76882-57A00) Type Retainers Nylon</p> <p>232 A 25 PCS 232 B 250 PCS 232 C 500 PCS</p>
<p>233 Head Diameter: 23/32" Stem Length: 29/32"; Fits 5/16" Hole Chrysler 1998-On Push-Type Retainers Black Nylon</p> <p>233 A 25 PCS 233 B 250 PCS 233 C 500 PCS</p>	<p>234 GM, Ford & Chrysler Head Diameter: 11/16 Stem Length: 5/8 Stem Diameter: 5/16 Plastic Shield Retainers Black Nylon</p> <p>234 A 25 PCS 234 B 250 PCS 234 C 500 PCS</p>	<p>235 GM 1987 - On Fits Into 1/2" Hole Bumper Fascia Push-Type Retainers Black Nylon</p> <p>235 A 25 PCS 235 B 250 PCS 235 C 500 PCS</p>
<p>236 Olds Cutlass Front Bumper Fascia Retainers Front Bumper Fascia Retainers</p> <p>236 A 25 PCS 236 B 250 PCS 236 C 500 PCS</p>	<p>237 Chrysler 1988-On Head Diameter: 7/8 Stem Length: 1-3/32 Stem Diameter: 5/16 Wheel Retainers</p> <p>237 A 50 PCS 237 B 250 PCS 237 C 500 PCS</p>	<p>238 Mitsubishi Front & Rear Bumpers Push-Type Bumper</p> <p>238 A 10 PCS 238 B 250 PCS 238 C 500 PCS</p>

Peter: 516-455-6331



Mike: 917-435-2648









Fax: 631- 648-9575

Email: XYZFastenersinc@gmail.com







www.xyzfasteners.com

PUSH TYPE RETAINERS

<p>239 Head Diameter: 5/8 Stem Length: 7/16" Fits Into 1/4 Hole Ford Push-Type Retainers Nylon</p>  <p>239 A 10 PCS 239 B 250 PCS 239 C 500 PCS</p>	<p>240 Head Diameter: 27mm Stem Length: 18mm Fits Into 9mm Hole; Cadillac 2000 - On Push-Type Retainers Nylon</p>  <p>240 A 10 PCS 240 B 250 PCS 240 C 500 PCS</p>	<p>241 Head Diameter: 18mm Stem Length: 18mm Fits Into 8mm Hole Ford 2000 - On Push- Type Retainers Nylon</p>  <p>241 A 10 PCS 241 B 250 PCS 241 C 500 PCS</p>
<p>242 Head Diameter: 16mm Stem Diameter: 4mm Stem Length: 21mm; Honda 1995 - On Bumper Retainers Blk. Nylon</p>  <p>242 A 15 PCS 242 B 250 PCS 242 C 500 PCS</p>	<p>243 Head Diameter: 18mm Stem Length: 8mm Fits Into 6mm Hole Toyota 1995 - On; Trim Panel Retainers Black Nylon</p>  <p>243 A 10 PCS 243 B 250 PCS 243 C 500 PCS</p>	<p>244 Hood Insulation Retainer Head Diameter: 20mm Stem Diameter: 14mm Stem Length: 10mm Mercedes 2002 - On OEM 001-988-03-25</p>  <p>244 A 15 PCS 244 B 250 PCS 244 C 500 PCS</p>
<p>245 Head Diameter: 10mm Stem Length: 10mm Fits Into 6mm Hole; Mercedes 1974-On BMW & VW Mercedes: 000-990-34-92; BMW: 51-16-1-881-149; VW: N-102-593-01</p>  <p>245 A 15 PCS 245 B 250 PCS 245 C 500 PCS</p>	<p>246 Nissan300 ZX; Head Diameter: 20mm 1990 - On Stem Lgth: 20mm Bumper Fascia</p>  <p>246 A 15 PCS 246 B 250 PCS 246 C 500 PCS</p>	<p>247 Head Diameter: 20mm Stem Length: 22mm; Fits Into 8mm Hole Nissan 1994 - On Push-Type Retainers</p>  <p>247 A 15 PCS 247 B 250 PCS 247 C 500 PCS</p>
<p>537 Head Diameter: 3/8" Stem D: 7/32, L: 5/8" Chrysler 1988-On Cowl & Dash Panel Retainers Blk. Nylon</p>  <p>537 A 50 PCS 537 B 250 PCS 537 C 500 PCS</p>	<p>538 Head Size: 5 x 15mm Stem Length: 9mm; Fits: 5mm Hole Gm 1997 - On Weatherstrip Retainers Nylon</p>  <p>538 A 100 PCS 538 B 250 PCS 538 C 500 PCS</p>	<p>539 Head Size: 7mm x 16mm Fits In 6mm Hole Nissan 1994 - On Weatherstrip Retainers B. Nylon</p>  <p>539 A 25 PCS 539 B 250 PCS 539 C 500 PCS</p>

RETAINERS		
<p>249 Chrysler Radiator Grille Retainers Nylon</p>  <p>249 A 25 PCS 249 B 250 PCS 249 C 500 PCS</p>	<p>250 Head Diameter: 15mm; Stem Length.: 13mm Fits 7mm Sq. Hole Honda 1993-On Push-Type Retainers Nylon</p>  <p>250 A 5 PCS 250 B 250 PCS 250 C 500 PCS</p>	<p>251 Head Diameter: 20mm Stem Length: 21mm Fits 8mm Hole Push-Type Retainers Nylon</p>  <p>251 A 5 PCS 251 B 250 PCS 251 C 500 PCS</p>
<p>252 GM Saturn Head Diameter: 1-3/16 Fits In 7/16 Hole Bumper Fascia Push- Type Retainers Nylon</p>  <p>252 A 10 PCS 252 B 250 PCS 252 C 500 PCS</p>	<p>381 Push-Type Retainers Head Dia: 19mm Stem Length: 16mm Fits Into 8mm Hole GM/Chry 2007-On GM/Chry 15296830</p>  <p>381 A 25 PCS 381 B 250 PCS 381 C 500 PCS</p>	<p>382 Push-Type Retainers Head Dia: 20mm Stem Length: 20mm Fits Into 8.5mm Hole GM 2007-On GM 11589292 Nylon</p>  <p>382 A 25 PCS 382 B 250 PCS 382 C 500 PCS</p>
<p>383 Fender Apron Push-Type Retainer Head Dia: 19MM Stem Len: 14MM Fits 8.5MM Hole 2006-2005 GM Cobalt</p>  <p>383 A 50 PCS 383 B 250 PCS 383 C 500 PCS</p>	<p>384 Top Hd Diameter: 13mm Stem Diameter: 10mm Lexus & Toyota 2003 – On Moulding Retainers Nylon</p>  <p>384 A 25 PCS 384 B 250 PCS 384 C 500 PCS</p>	<p>385 Top Head Diameter: 12mm Middle Head Diameter: 16mm Bottom Head Diameter: 18mm Stem Diameter: 9.7mm Stem Length: 14mm Honda CRV & Fit 2003 - On O.E.M. 90602-SAA-003 Orange Nylon</p>  <p>385 A 15 PCS 385 B 250 PCS 385 C 500 PCS</p>

DOMESTIC RETAINERS BLACK NYLON

<p>301 1/4" (6.4mm) Hole Size Head: 1 5/8" Stem: 3/4" Black Nylon Hood Insulation Retainers G.M. # 20064875</p>  <p>301 A 25 PCS 301 B 250 PCS 301 C 500 PCS</p>	<p>302 1/4" (6.4mm) Hole Size Head: 2" Black Polypropylene Hood Insulation Retainers G.M. # 3078511</p>  <p>302 A 20 PCS 302 B 250 PCS 302 C 500 PCS</p>	<p>303 1/4" (6.4mm) Hole Size Head Diameter: 1 5/16" Stem Length: 13/16" Black Nylon Hood Insulation Retainers Chrysler # 4341060</p>  <p>303 A 25 PCS 303 B 250 PCS 303 C 500 PCS</p>
<p>304 Head Diameter 11/16 Fits Into 1/4 Hole GM #140192051</p>  <p>304 A 50 PCS 304 B 250 PCS 304 C 500 PCS</p>	<p>305 5/16" (7.8mm) Hole Size Flange: 17mm Stem: 13.5mm Radiator & Windshield Bottle G.M. # 14071289</p>  <p>305 A 30 PCS 305 B 250 PCS 305 C 500 PCS</p>	<p>306 5/16" (8mm) Hole Size Panel Range: 3.5mm - 7.9mm Flange: 25mm Stem: 23mm Spare Tire Blind Rivets G.M. # 20570245</p>  <p>306 A 30 PCS 306 B 250 PCS 306 C 500 PCS</p>
<p>307 5/16" (8mm) Hole Size Flange Diameter: 15mm Stem Length: 20mm Black Nylon Rocker Panel Retainers G.M. # 21075686</p>  <p>307 A 25 PCS 307 B 250 PCS 307 C 500 PCS</p>	<p>308 5/16" (8mm) Hole Size Flange Diameter: 20mm Stem Length: 20mm G.M. # 21030249</p>  <p>308 A 25 PCS 308 B 250 PCS 308 C 500 PCS</p>	<p>309 5/16" (8mm) Hole Size Flange Diameter: 20mm Stem Length: 26mm G.M. # 11518017</p>  <p>309 A 15 PCS 309 B 250 PCS 309 C 500 PCS</p>
<p>310 15/64" (6mm) Hole Size Flange: 14mm Stem: 16mm Cowl Panel to Reinf. Plate & Engine Splash Shield Nissan # 66860-01W01</p>  <p>310 A 50 PCS 310 B 250 PCS 310 C 500 PCS</p>	<p>311 5/16" (8mm) Hole Size Flange Diameter: 18mm Stem Length: 12mm Ford # MB-455-56143</p>  <p>311 A 25 PCS 311 B 250 PCS 311 C 500 PCS</p>	<p>312 1/4" (6.3mm) Hole Size Flange Diameter: 1" Stem Length: 7/8" Ford # N-804837-S</p>  <p>312 A 25 PCS 312 B 250 PCS 312 C 500 PCS</p>

Peter: 516-455-6331













Mike: 917-435-2648









Fax: 631- 648-9575

Email: XYZFastenersinc@gmail.com









www.xyzfasteners.com

DOMESTIC RETAINERS BLACK & NYLON

<p>313 1/4" (6.4mm) Hole Size Flange Diameter: 11/16" Stem Length: 29/32" Black Nylon Exterior Body Retainers G.M. # 20590899</p>  <p>313 A 25 PCS 313 B 250 PCS 313 C 500 PCS</p>	<p>314 1/4" (6.3mm) Square Hole Flange Dia.: 15/32" x 15/32" Flange Diameter: 21/32" Trim & Grille Ford #N803494S14</p>  <p>314 A 25 PCS 314 B 250 PCS 314 C 500 PCS</p>	<p>315 1/4" (6.4mm) Hole Size Panel Range: .098" - .350" Flange: 1" Stem: 29/32" G.M. # 14093088</p>  <p>315 A 25 PCS 315 B 250 PCS 315 C 500 PCS</p>
<p>316 1/4" (6.4mm) Hole Size Flange: 19/32" Stem: 3/4" Black Nylon Wheel Opening G.M. # 21077123</p>  <p>316 A 25 PCS 316 B 250 PCS 316 C 500 PCS</p>	<p>317 15/64" (6mm) Hole Size Flange: 17mm Stem: 16mm Wheelhouse & Fender G.M. # 15149708</p>  <p>317 A 25 PCS 317 B 250 PCS 317 C 500 PCS</p>	<p>318 1/4" (6.3mm) Hole Size Flange Diameter: 11/16" Stem Length: 29/32" Black Nylon Radiator Shroud Blind Ford # N804570S</p>  <p>318 A 25 PCS 318 B 250 PCS 318 C 500 PCS</p>
<p>322 Flange Diameter: 30mm Stem Length: 24mm Black Nylon Front Air Deflector Retainers (Use With # 19614) G.M. # 15733971</p>  <p>322 A 10 PCS 322 B 250 PCS 322 C 500 PCS</p>	<p>323 Flange Diameter: 28mm Stem Length: 13mm Front Air Deflector Grommets (Use With # 19613) G.M. # 15733970</p>  <p>323 A 10 PCS 323 B 250 PCS 323 C 500 PCS</p>	<p>324 1/4" (6.4mm) Hole Size Head Diameter: 1 3/16" Stem Length: 3/4" Ford # 386553-S</p>  <p>324 A 25 PCS 324 B 250 PCS 324 C 500 PCS</p>
<p>325 21/64" (8.5mm) Hole Size Panel Range: 4.5mm - 7mm Flange: 20mm Stem: 22mm G.M. # 11589293</p>  <p>325 A 25 PCS 325 B 250 PCS 325 C 500 PCS</p>	<p>326 21/64" (8.5mm) Hole Size Panel Range: 7mm - 10mm Flange: 20mm Stem: 24mm G.M. # 11589294</p>  <p>326 A 25 PCS 326 B 250 PCS 326 C 500 PCS</p>	<p>327 1/2" (12.7mm) Hole Size Flange: 1" Shoulder: 3mm Stem Length: 1" Black Nylon Bumper Fascia Blind Rivets G.M. # 22535007</p>  <p>327 A 25 PCS 327 B 250 PCS 327 C 500 PCS</p>

ROCKER PANEL MOULDING CLIPS		
<p>328 7/16" (11mm) Hole Size Top Head Dia.: 11/16" x 1 1/2" Stem Length: 1 1/4" Gray G.M. # 10431761</p> <p>328 A 10 PCS 328 B 250 PCS 328 C 500 PCS</p>		<p>329 Head Size: 11/16 x 1- 5/16" Fits In 5/16 Hole Gm 2000 – On</p> <p>329 A 15 PCS 329 B 250 PCS 229 C 500 PCS</p>
<p>330 3/8" (9.5mm) Hole Size Top Head Dia.: 9/16" x 13/16" Stem Length: 9/16" White Nylon G.M. # 25724529</p> <p>330 A 15 PCS 330 B 250 PCS 330 C 500 PCS</p>		
<p>331 7/16" (11mm) Hole Size Top Head Dia.: 9/16" x 3/4" Stem Length: 9/16" Gray G.M. # 25693852</p> <p>331 A 25 PCS 331 B 250 PCS 331 C 500 PCS</p>		<p>332 7/16" (11mm) Hole Size Top Head Dia.: 3/4" x 1" Stem Length: 19/32" White Nylon Rocker Panel Moulding Clips G.M. # 22603384</p> <p>332 A 15 PCS 332 B 250 PCS 332 C 500 PCS</p>
<p>333 7/16" (11mm) Hole Size Top Head Dia.: 9/16" x 13/16" Stem Length: 9/16" Natural Nylon G.M. # 11518357</p> <p>333 A 15 PCS 333 B 250 PCS 333 C 500 PCS</p>		
<p>334 7/16" (11mm) Hole Size Top Head Dia.: 15/32" x 13/16" Stem Length: 9/16" Green G.M. # 10423553</p> <p>334 A 15 PCS 334 B 250 PCS 334 C 500 PCS</p>		<p>340 Hyundai 2002 – On</p> <p>340 A 15 PCS 340 B 250 PCS 340 C 500 PCS</p>
<p>341 Hyundai 2002 - On</p> <p>341 A 15 PCS 341 B 250 PCS 341 C 500 PCS</p>		
<p>342 With sealer top head size 9/16" x 25/32 bottom head size 5/8"x13/16"</p> <p>342 A 10 PCS 342 B 250 PCS 342 C 500 PCS</p>		<p>343 Top Head Size: 12mm x 20mm Bottom Head Size: 12mm x 24mm Stem Length: 16mm On GM: 11609923 Gray</p> <p>343 A 15 PCS 343 B 250 PCS 343 C 500 PCS</p>
<p>344 Top Head Size: 12mm x 20mm Pontiac 2004-On</p> <p>344 A 15 PCS 344 B 250 PCS 344 C 500 PCS</p>		

ROCKER MOULDING CLIPS

<p>345 Top Head Size: 16mm x 18mm Bottom Head Size: 18mm x 20mm Stem Length: 15mm Fits Into 10mm Hole Honda: 91504-SP1-003</p>  <p>345 A 25 PCS 345 B 250 PCS 345 C 500 PCS</p>	<p>346 Fender Flare & Bumper Clip Head Size: 13mm x 26mm Stem Length: 24mm 75392-35200, 75392-04010 Blue Nylon</p>  <p>346 A 15 PCS 346 B 250 PCS 346 C 500 PCS</p>	<p>348 Hyundai Entourage, Tucson & Veracruz and Kia Optima, Sedona, Spectra & Sport age 2005 - On O.E.M. 87756-2E000</p>  <p>348 A 15 PCS 348 B 250 PCS 348 C 500 PCS CS</p>
<p>349 Buick Terraza, Chevrolet Uplander, GMC Arcadia, Pontiac Montana SV6 and Saturn Relay 2005-On GM: 15127746 White Nylon</p>  <p>349 A 15 PCS 349 B 250 PCS 349 C 500 PCS</p>	<p>350 With Sealer Top Head Size: 16mm x 18mm Bottom Head Size: 18mm x 20mm Stem Length: 15mm With Sealer Hyundai Azera & Genesis 2009 - On Hyundai: 87758-3L000 Blue Nylon</p>  <p>350 A 15 PCS 350 B 250 PCS 350 C 500 PCS</p>	<p>351 Rocker Moulding Clip With Sealer Top Head Size: 12mm x 20mm Bottom Head Size: 12mm x 20mm Stem Length: 11mm Fits Into 9mm Hole Chevrolet Traverse 2010 - On GM: 11571175 Gray Nylon</p>  <p>351 A 15 PCS 351 B 250 PCS 351 C 500 PCS</p>
<p>352 Windshield Pillar Moulding Clip Top Head Size: 12 x 20MM Bottom Head Size: 14 x 20MM Stem Len: 15MM Fits 9MM Hole Chevrolet Equinox & Pontiac Torrent 2005 - On OEM: 15288146, 15893516 Gray Nylon</p>  <p>352 A 15 PCS 352 B 250 PCS 352 C 500 PCS</p>	<p>353 Rocker Moulding Clip With Sealer Top Head Size: 10mm x 11mm Bottom Head Size: 14mm x 19mm Stem Length: 10mm Hyundai Accent, Santa Fe & Tiburon 1995 - On O.E.M 87758-35000 Yellow Nylon</p>  <p>353 A 15 PCS 353 B 250 PCS 353 C 500 PCS</p>	<p>354 Chevrolet 2000 - On Rocker Panel Moulding Clips Nylon</p>  <p>354 A 15 PCS 354 B 250 PCS 354 C 500 PCS</p>

Peter: 516-455-6331





Mike: 917-435-2648

Fax: 631- 648-9575

Email: XYZFastenersinc@gmail.com

www.xyzfasteners.com

DOORT TRIM PANEL

<p>359 Door Trim Panel Retainer With Sealer Top Head Diameter: 14mm Bottom Head Diameter: 18mm Stem Length: 14mm Mazda 3,5,6,CX-7, Miata & Protégé 2001-On Mazda G18K-51-SJ3 White Nylon</p>  <p>359 A 25 PCS 359 B 250 PCS 359 C 500 PCS</p>	<p>360 Door Panel Retainer Top Head Diameter: 13mm Middle Head Diameter: 16mm Bottom Head Diameter: 15mm Stem Diameter: 9.5mm Stem Length: 13mm Honda & Acura 91560-S9A-A01 Blue Nylon</p>  <p>360 A 25 PCS 360 B 250 PCS 360 C 500 PCS</p>	<p>361 Trim Panel Retainer With Sealer Top Head Diameter: 13mm Middle Head Diameter: 16mm Bottom Head Diameter: 18mm Stem Diameter: 9mm Stem Length: 13mm</p>  <p>361 A 25 PCS 361 B 250 PCS 361 C 500 PCS</p>
<p>362 (90467-A0005) White Nylon With Sealer Top Head Diameter: 13mm Middle Head Diameter: 16mm Bottom Head Diameter: 18mm Stem Diameter: 8.5mm Stem Length: 14mm Lexus ES 350, GX 470, IS 250, IS 350, IS F, LS 460 & LS 600HL and Toyota Camry, FJ Cruiser, Highlander, RAV4 & 4-Runner</p>  <p>362 A 25 PCS 362 B 250 PCS 362 C 500 PCS</p>	<p>363 (Mazda: 9927-40-822; Toyota: 62581-14020) Trim Panel Retainer Small Head Dia: 14mm Large Head Dia: 18mm Stem Length: 14mm Fits Into 8mm Hole Natural Nylon</p>  <p>363A 25 PCS 363 B 250 PCS 363 C 500 PCS</p>	<p>364 Top Head Diameter: 13mm Bottom Hd Diameter: 18mm; Stem Length: 13mm Toyota & Lexus 98-On Retainers</p>  <p>364 A 25 PCS 364 B 250 PCS 364 C 500 PCS</p>
<p>372 Toyota Truck Flange Diameter: 15mm Fits Into 8mm Hole Door Panel Retainers Nylon</p>  <p>372 A 25 PCS 372 B 250 PCS 372 C 500 PCS</p>	<p>373 Sm. Head Diameter: 19/32" Stem Length. 5/8" Fits In 1/4" Hole Chrysler Trim Panel Retainers G. Nylon</p>  <p>373 A 25 PCS 373 B 250 PCS 373 C 500 PCS</p>	<p>374 Head Diameter: 13mm, 16mm & 18mm Stem Length: 14mm Toyota 2004 - On Panel Retainers</p>  <p>374 A 25 PCS 374 B 250 PCS 374 C 500 PCS</p>

Peter: 516-455-6331

Mike: 917-435-2648

Fax: 631- 648-9575

Email: XYZFastenersinc@gmail.com

www.xyzfasteners.com

MOULDING CLIPS

<p>355 Door Cladding Moulding Clip With Sealer Top Head Size: 15mm x 20mm Bottom Head Size: 20mm x 24mm Stem Length: 11mm Fits Into 11mm Hole</p>  <p>355 A 15 PCS 355 B 250 PCS 355 C 500 PCS</p>	<p>357 Hd: 1/2 x 1-3/16 Stem Length: 27/32" Jeep 2002 - On Fascia Clips Nylon</p>  <p>357 A 10 PCS 357 B 250 PCS 357 C 500 PCS</p>	<p>358 Fender Flare Moulding Clip Top Head Size: 14 x 38MM Bottom Head Size: 16 x 38MM Stem Len: 15MM Fits 9MM Hole Gray Nylon Jeep Liberty 2005 - On OEM: 55157055-AA, 55157065-AA</p>  <p>358 A 15 PCS 358 B 250 PCS 358 C 500 PCS</p>
<p>375 Rocker Panel Moulding Clip w/Sealer Top Hd: 20MM x 30MM Overall Len: 28MM Fits 17MM Hole Chevrolet Equinox & Pontiac Torrent 2002 - On OEM: 11561491, 15872008</p>  <p>375 A 10 PCS 375 B 250 PCS 375 C 500 PCS</p>	<p>376 Moulding Clips Top Head Size: 3/4 x 1-1/32 Fits Into 3/8 Hole Chevrolet 2004-On GM 11589176 Nylon</p>  <p>376 A 10 PCS 376 B 250 PCS 376 C 500 PCS</p>	<p>377 Head: 16mm x 20mm Stem Length: 9mm Lexus 1997 - On Moulding Clips</p>  <p>377 A 10 PCS 377 B 250 PCS 377 C 500 PCS</p>
<p>378 Front & Rear Door Exterior Trim Moulding Clip Top Head Size: 12mm x 15mm Bottom Head Size: 14mm x 20mm Stem Length: 9mm Acura RDX 2009 -07 Acura: 75315-STK-A01 White Nylon</p>  <p>378 A 15 PCS 378 B 250 PCS 378 C 500 PCS</p>	<p>379 Drip Moulding Honda Civic 1995 - On Moulding Clips Nylon</p>  <p>379 A 15 PCS 379 B 250 PCS 379 C 500 PCS</p>	<p>380 Chrysler 1978 - On Wheel Opening Moulding Clip Moulding Fasteners Nylon</p>  <p>380 A 50 PCS 380 B 250 PCS 380 C 500 PCS</p>

Peter: 516-455-6331









Mike: 917-435-2648

Fax: 631- 648-9575

Email: XYZFastenersinc@gmail.com

www.xyzfasteners.com

RETAINERS

<p>347</p> <p>Push-Type Retainer Head Dia: 20mm Stem Length: 11mm Fits Into 10mm Hole Honda 2010 – On O.E.M. 91503-S7A-003</p>  <p>347 A 20 PCS 347 B 250 PCS 347 C 500 PCS</p>	<p>356</p> <p>Bumper & Fender Apron Nylon "U" Nut Screw Size: M5.5 (#12) Width: 20mm, Length: 36mm Center Of Hole To Edge: 14mm Panel Range: Up To 1mm Lexus & Toyota 2000-On Lexus & Toyota 90467-05114</p>  <p>356 A 10 PCS 356 B 250 PCS 356 C 500 PCS</p>	<p>365</p> <p>Hood Insulation Retainer Head Diameter: 30mm Stem Diameter: 21mm Stem Length: 14mm Honda Civic 2012 - On Honda: 91501-SWA-003</p>  <p>365 A 25 PCS 365 B 250 PCS 365 C 500 PCS</p>
<p>366</p> <p>Head Diameter: 20mm Stem Length: 17mm Chrysler 2001 - On Push-Type Retainers Nylon</p>  <p>366 A 25 PCS 366 B 250 PCS 366 C 500 PCS</p>	<p>367</p> <p>Push-Type Retainers Head Dia: 18mm Stem Length: 17.5mm Fits Into 6.5mm Hole GM/Chry 2002-On GM/Chry 11589289 Nylon</p>  <p>367 A 25 PCS 367 B 250 PCS 367 C 500 PCS</p>	<p>368</p> <p>Push-Type Retainers Head Dia: 18mm Stem Length: 22mm Fits Into 6.5mm Hole GM/Ford 2003-On GM/Ford 11589291 Nylon</p>  <p>368 A 25 PCS 368 B 250 PCS 368 C 500 PCS</p>
<p>369</p> <p>Air Inlet Grille, Bumper Fascia & Front Caliper Cooling Duct Push-Type Retainer Head Dia: 18MM Stem Len: 20MM Fits 6.5MM Hole Black Nylon (GM: 11589290; Chrys: 6509049AA)</p>  <p>369 A 25 PCS 369 B 250 PCS 369 C 500 PCS</p>	<p>370</p> <p>Push-Type Retainer Type : Push-Type with Closed End Head Diameter : 16MM Stem Length : 18MM Hole Size : 7MM Color : Black OEM : (1249900492)</p>  <p>370 A 15 PCS 370 B 250 PCS 370 C 500 PCS</p>	<p>371</p> <p>Bamper, wheel openin,scuff plate & interior trim Head Dia: 20 mm Stem Length: 15mm Fits 6.3MM Hole Serie 3,5,7,& x5 1989-on</p>  <p>371 A 50 PCS 371 B 250 PCS 371 C 500 PCS</p>

Peter: 516-455-6331













Mike: 917-435-2648

Fax: 631- 648-9575













Email: XYZFastenersinc@gmail.com

www.xyzfasteners.com

WEATHER STRIPS / HOOD RETAINERS

<p>401 Size: 5mm x 15mm Stem Length: 8mm Ford 1999 - On</p>  <p>401 A 10 PCS 401 B 250 PCS 401 C 500 PCS</p>	<p>402 Toyota 4-Runner 1989-83</p>  <p>402 A 10 PCS 402 B 250 PCS 402 C 500 PCS</p>	<p>403 Head Size: 5mm x 15mm Honda 1992-On</p>  <p>403 A 25 PCS 403 B 250 PCS 403 C 500 PCS</p>
<p>404 Head: 5mm x 15mm Stem Length: 10mm; Fits In 6mm Hole Honda 1995 - On</p>  <p>404 A 10 PCS 404 B 250 PCS 404 C 500 PCS</p>	<p>405 13/64" (5mm) Hole Size Head Dia.: 5mm x 15mm Stem Length: 10mm Green Honda # 91568-SR2-003</p>  <p>405 A 100 PCS 405 B 250 PCS 405 C 500 PCS</p>	<p>406 13/64" (5mm) Hole Size Head Dia.: 6.5mm x 16.5mm Stem Length: 10.5mm White Nylon Chrysler # 4696129</p>  <p>406 A 50 PCS 406 B 250 PCS 406 C 500 PCS</p>
<p>407 15/64" (6mm) hole Size Head Dia.: 5.25mm x 14.2mm Stem Length: 12.3mm Black Nylon weather strip.</p>  <p>407 A 25 PCS 407 B 250 PCS 407 C 500 PCS</p>	<p>408 3/16" (4.5mm) Hole Size Head Dia.: 4.75mm x 13.5mm Stem Length: 12mm Weather strip Retainers G.M. # 4876498</p>  <p>408 A 100 PCS 408 B 250 PCS 408 C 500 PCS</p>	<p>409 Honda Width: 7mm Length: 16mm 90664-671-0030, 91530-SEO-003</p>  <p>409 A 50 PCS 409 B 250 PCS 409 C 500 PCS</p>
<p>410 3/16" (4.5mm) Hole Size Head Dia.: 5mm x 13mm Stem Length: 16mm Natural Nylon Ford # C5AB-6220586A</p>  <p>410 A 50 PCS 410 B 250 PCS 410 C 500 PCS</p>	<p>411 13/64" (5.3mm) Hole Size Panel Range: .030" - .285" Head: 10mm Stem: 11.5mm G.M. # 20699808</p>  <p>411 A 50 PCS 411 B 250 PCS 411 C 500 PCS</p>	<p>412 GM 1967 - On GM 8731909</p>  <p>412 A 100 PCS 412 B 250 PCS 412 C 500 PCS</p>

XYZ FASTENERS

<p>413 3/16" (4.5mm) Hole Size Head Diameter: 7/16" Stem Length: 1/2" Black Ford # N803170-S</p>  <p>413 A 25 PCS 413 B 250 PCS 413 C 500 PCS</p>	<p>414 3/16" (4.5mm) Hole Size Panel Range: .125" - .310" Head: 3/8" Stem: 17/32" Black G.M. # 2964547</p>  <p>414 A 25 PCS 414 B 250 PCS 414 C 500 PCS</p>	<p>415 Head Diameter 7/16" Stem Diameter: 7/32" Stem Length: 11/16" Chrysler</p>  <p>415 A 50 PCS 415 B 250 PCS 415 C 500 PCS</p>
<p>416 GM 1977 - On Trim Panel Retainers</p>  <p>416 A 50 PCS 416 B 250 PCS 416 C 500 PCS</p>	<p>417 Engine Under Cover Head Diameter: 20mm Stem Length: 10mm Fits Into 7mm Holler Lexus & Toyota 90467-07201</p>  <p>417 A 25 PCS 417 B 250 PCS 417 C 500 PCS</p>	<p>418 1/4" (6.3mm) Hole Size Flange Diameter: 15mm Stem Length: 13mm G.M. # 96057846</p>  <p>418 A 25 PCS 418 B 250 PCS 418 C 500 PCS</p>
<p>420 Fender Apron Head Diameter: 20mm Stem Length: 12mm Fits Into 9mm Square Hole Grommet Honda & Acura OEM: 90682-SEA-003</p>  <p>420 A 25 PCS 420 B 250 PCS 420 C 500 PCS</p>	<p>451 NISSAN & TOYOTA</p>  <p>OEM# 01553- 00172, 90467-07050, 94467-08008.</p> <p>451 A 25 PCS 451 B 250 PCS 451 C 500 PCS</p>	<p>422 Toyota Bumper, Radiator Cover and Grille Push-Type Retainer Head Diameter: 19mm Stem Length: 8mm Camry & Highlander 2005 - On OEM: 90467-07211</p>  <p>422 A 25 PCS 422 B 250 PCS 422 C 500 PCS</p>
<p>501 Weather-strip Retaining Clip Head Diameter: 9mm Stem Diameter: 5.5mm Stem Length: 7mm Mazda 2007 - On Mazda: BP4K-58-762</p>  <p>501 A 25 PCS 501 B 250 PCS 501 C 500 PCS</p>	<p>503 11/64" (4.2mm) Hole Size Head Diameter: 11mm Stem Length: 12mm G.M. # 20538173</p>  <p>503 A 50 PCS 503 B 250 PCS 503 C 500 PCS</p>	<p>504 15/64" (6mm) Hole Size Head Diameter: 14mm Stem Length: 10mm Black Nylon Hood Insulation Ford # F1CZ-16774-A</p>  <p>504 A 50 PCS 504 B 250 PCS 504 C 500 PCS</p>

Peter: 516-455-6331











Mike: 917-435-2648

Fax: 631- 648-9575

Email: XYZFastenersinc@gmail.com

www.xyzfasteners.com

XYZ FASTENERS

<p>505 Honda Head Diameter: 13mm Fits In 5mm Hole</p>  <p>505 A 25 PCS 505 B 250 PCS 502 C 500 PCS</p>	<p>506 Nissan Head Diameter 14mm Fits Into 6mm Hole</p>  <p>506 A 50 PCS 506 B 250 PCS 506 C 500 PCS</p>	<p>507 Head Size:7mm x 16mm Stem Length: 12mm Fits Into 5Mm Hole Honda Hood Seal</p>  <p>507 A 50 PCS 507 B 250 PCS 507 C 500 PCS</p>
<p>510 Honda & Acura Head Diameter: 10mm Fits: 6mm Hole</p>  <p>510 A 25 PCS 510 B 250 PCS 510 C 500 PCS</p>	<p>511 Head Diameter: 12mm Stem Length: 9mm Acura & Honda</p>  <p>511 A 25 PCS 511 B 250 PCS 511 C 500 PCS</p>	<p>512 Toyota Head Diameter: 13mm Fits: 5mm Hole</p>  <p>512 A 50 PCS 512 B 250 PCS 512 C 500 PCS</p>
<p>513 GM, Ford, & AMC 7/16 Head Diameter 5/8 Stem Length</p>  <p>513 A 50 PCS 513 B 250 PCS 513 C 500 PCS</p>	<p>514 Head Diameter:3/8" Stem Diameter: 7/32" Stem Length: 5/8"</p>  <p>514 A 50 PCS 514 B 250 PCS 514 C 500 PCS</p>	<p>515 GM Head Diameter: 19/32" Stem Length: 3/4" Shroud Retainers</p>  <p>515 A 25 PCS 515 B 250 PCS 515 C 500 PCS</p>
<p>521 H d Size:6mm x 16mm Fits In 6mm Hole Honda Odyssey 1999 - On Cowl Vent Retaining Clips</p>  <p>521 A 15 PCS 521 B 250 PCS 521 C 500 PCS</p>	<p>522 Fits 3/16" Hole Tail Light Push-Type Retainers Nylon</p>  <p>522 A 25 PCS 522 B 250 PCS 522 C 500 PCS</p>	<p>523 Toyota Head Diameter: 14mm Fits 5mm Hole Retaining Clips</p>  <p>523 A 25 PCS 523 B 250 PCS 523 C 500 PCS</p>













Peter: 516-455-6331

Mike: 917-435-2648

Fax: 631- 648-9575

Email: XYZFastenersinc@gmail.com

www.xyzfasteners.com

WEATHER STRIPS / HOOD & PUSH -TYPE RETAINER		
<p>524 Honda Head Diameter: 13mm Stem Length: 16mm Xmas Tree Retainers Nylon</p>  <p>524 A 25 PCS 524 B 250 PCS 524 C 500 PCS</p>	<p>525 Weathers trip Retainer Head Diameter: 8mm Stem Diameter: 5.3mm Stem Length: 7mm Nissan Murano & Rouge 2012- 03 Nissan: 80850-CA003</p>  <p>525 A 15 PCS 525 B 250 PCS 525 C 500 PCS</p>	<p>526 Weatherstrip Retaining Clip Head Diameter: 10mm Stem Diameter: 6mm Stem Length: 8mm Nissan Altima 2009 - On Nissan: 01553-08961</p>  <p>526 A 25 PCS 526 B 250 PCS 526 C 500 PCS</p>
<p>527 Hood Sea l Retaining Clip Head Size: 6.4mm x 16mm Stem Diameter: 3.5mm x 6mm Stem Length: 10mm Infiniti I30, I35, Q45 & QX4 and Nissan Maxima & Pathfinder 2004 – 1996 O.E.M. 65810-K2000</p>  <p>527 A 25 PCS 527 B 250 PCS 527 C 500 PCS</p>	<p>528 Head Diameter: 23/64" Stem Diameter: 3/16" Stem Length: 7/16" Gm 1991 - On Door Lock</p>  <p>528 A 100 PCS 528 B 250 PCS 528 C 500 PCS</p>	<p>529 Head Diameter: 11mm Fits Into 6mm Hole Honda Odyssey 1999 - On Hood Seal Retaining Clips Black Nylon</p>  <p>529 A 25 PCS 529 B 250 PCS 529 C 500 PCS</p>
<p>530 Push-Type Retainer Head Dia: 10mm Stem Length: 12mm Fits Into 5mm Hole Toyota 2009 - On OEM 90467-05090-B1</p>  <p>530 A 10 PCS 530 B 250 PCS 530 C 500 PCS</p>	<p>531 Honda Retaining Clips</p>  <p>531 A 25 PCS 531 B 250 PCS 531 C 500 PCS</p>	<p>532 Nissan & Datsun Retaining Clips Nylon</p>  <p>532 A 25 PCS 532 B 250 PCS 532 C 500 PCS</p>
<p>533 Head Diameter: 20mm Fits Into 6mm Hole Mazda Push-Type Retainers Nylon</p>  <p>533 A 25 PCS 533 B 250 PCS 533C 500 PCS</p>	<p>534 Head Diameter 25mm Stem Diameter: 8mm Stem Length: 12mm Lexus & Toyota Hood Insulation Retainers Nylon</p>  <p>534 A 15 PCS 534 B 250 PCS 534 C 500 PCS</p>	<p>535 Ford Head Diameter: 1/2" Stem Length: 5/8" Trim Panel Retainers</p>  <p>535 A 25 PCS 535 B 250 PCS 535 C 500 PCS</p>

Peter: 516-455-6331

Mike: 917-435-2648

Fax: 631- 648-9575

Email: XYZFastenersinc@gmail.com

www.xyzfasteners.com

DOOR PANEL CLIPS

<p>601 GM 1990 - On Trim Panel Retainers G.M. # 10153057</p>  <p>601 A 25 PCS 601 B 250 PCS 601 C 500 PCS</p>	<p>602 Ford Head Diameter: 25/32" Stem Diameter: 5/16"; Stem Length: 5/8 Door Trim Panel Retainers</p>  <p>602 A 25 PCS 602 B 250 PCS 602 C 250 PCS</p>	<p>603 Ford 1985 - On Sm. Head Diameter: 1/2 Stem Length: 3/4 Stem Diameter: 11/32</p>  <p>603 A 25 PCS 603 B 250 PCS 603 C 250 PCS</p>
<p>604 Top Head Diameter: 14mm Stem Diameter: 9mm Stem Length: 14mm; Vw 1979-On</p>  <p>604 A 25 PCS 604 B 250 PCS 604 C 500 PCS</p>	<p>605 GM # 95005064 9MM 13MM HD GM & Toyota Trim Panel Retainers</p>  <p>605 A 25 PCS 605 B 250 PCS 605 C 500 PCS</p>	<p>606 Large Head Diameter: 18mm Stem Diameter: 9mm Toyota 1991 - On Trim Panel Retainers</p>  <p>606A 25 PCS 606 B 250 PCS 606 C 500 PCS</p>
<p>607 Large Head Diameter: 17mm Stem Diameter: 9.5mm Honda 1991 - On Trim Panel Retainers</p>  <p>607 A 25 PCS 607 B 250 PCS 607 C 500 PCS</p>	<p>608 5/16" (8mm) Hole Size Top Head Diameter: 1/2" Stem Length: 21/32" White Ford # 387477-S</p>  <p>608 A 25 PCS 608 B 250 PCS 608 C 500 PCS</p>	<p>609 GM Head Diameter: 7/8" Stem Length: 3/4 Stem Diameter: 5/16 In Door</p>  <p>609 A 40 PCS 609 B 250 PCS 609 C 500 PCS</p>
<p>610 Chevrolet Truck & GMC 1977 - On Trim Panel Retainers</p>  <p>610 A 25 PCS 610 B 250 PCS 610 C 500 PCS</p>	<p>611 GM Stem Diameter: 5/16" Stem Length: 3/4"</p>  <p>611 A 25 PCS 611 B 250 PCS 611 C 500 PCS</p>	<p>612 GM Head Diameter 15/16" Length: 1-1/4" 1987 - On Trim Panel</p>  <p>612 A 25 PCS 612 B 250 PCS 612 C 500 PCS</p>









Peter: 516-455-6331

Mike: 917-435-2648

Fax: 631- 648-9575

Email: XYZFastenersinc@gmail.com

www.xyzfasteners.com

DOOR TRIM PANEL RETAINERS CLIPS		
<p>613 GM Trucks Head Diameter: 9/16" Fits Into 1/4 Hole Trim Panel Push-</p> <p>613 A 25 PCS 613 B 250 PCS 613 C 500 PCS</p>		<p>614 Ford Sm. Head Diameter 1/2 Lg. Head Diameter: 3/4</p> <p>614 A 25 PCS 614 B 250 PCS 614 C 500 PCS</p>
<p>616 Top Head Diameter: 14mm Stem Diameter: 9mm Stem Length: 15mm; Bmw 1987 - On</p> <p>616 A 25 PCS 616 B 250 PCS 616 C 500 PCS</p>		<p>617 AMC Head Diameter: 3/4" Stem Lgth: 11/16 Fits In 5/16 Hole Door</p> <p>617 A 25 PCS 617 B 250 PCS 617 C 500 PCS</p>
<p>619 SM. HD. DIA. 1/2 STEM DIA. 3/8 Stem Length: 11/16" Ford Trim Panel Retainers NYLON</p> <p>619 A 25 PCS 619 B 250 PCS 619 C 500 PCS</p>		<p>620 GM Head Diameter: 3/4" Length: 3/4" 1982 - On Door Panel Retainers Nylon</p> <p>620 A 25 PCS 620 B 250 PCS 620 C 500 PCS</p>
<p>622 Small Head Diameter: 1/2" Large Head Diameter: 23/32" Stem Length: 9/16" Chrysler Door Trim Panel</p> <p>622 A 25 PCS 622 B 250 PCS 622 C 500 PCS</p>		<p>621 GM Head Diameter: 18mm Stem Diameter: 9mm Stem Length: 18mm Trim Panel Retainers</p> <p>621 A 25 PCS 621 B 250 PCS 621 C 500 PCS</p>
<p>623 Toyota Camry Door Trim Retainers Door Trim</p> <p>623 A 50 PCS 623 B 250 PCS 623 C 500 PCS</p>		<p>624 Top Head Diameter: 13mm Bottom Head Diameter: 17mm Stem Diameter: 9mm Stem Length: 14mm Mercedes-Benz 1996 - On Green Nylon (007-988-99-78, 007-988-34-78)</p> <p>624 A 10 PCS 624 B 250 PCS 624 C 500 PCS</p>
<p>615 Lg. Head Diameter 16mm Stem Diameter: 9mm Toyota</p> <p>615 A 25 PCS 615 B 250 PCS 615 C 500 PCS</p>		<p>618 Lg. Head Diameter: 3/4 Stem Length: 1" Ford # N805612-S100</p> <p>618 A 25 PCS 618 B 250 PCS 618 C 500 PCS</p>
<p>618 Lg. Head Diameter: 3/4 Stem Length: 1" Ford # N805612-S100</p> <p>618 A 25 PCS 618 B 250 PCS 618 C 500 PCS</p>		<p>624 Top Head Diameter: 13mm Bottom Head Diameter: 17mm Stem Diameter: 9mm Stem Length: 14mm Mercedes-Benz 1996 - On Green Nylon (007-988-99-78, 007-988-34-78)</p> <p>624 A 10 PCS 624 B 250 PCS 624 C 500 PCS</p>
<p>624 Top Head Diameter: 13mm Bottom Head Diameter: 17mm Stem Diameter: 9mm Stem Length: 14mm Mercedes-Benz 1996 - On Green Nylon (007-988-99-78, 007-988-34-78)</p> <p>624 A 10 PCS 624 B 250 PCS 624 C 500 PCS</p>		

Peter: 516-455-6331













Mike: 917-435-2648

Fax: 631- 648-9575

Email: XYZFastenersinc@gmail.com

www.xyzfasteners.com

PLASTIC GROMMETS

<p>2401 #10 (4.8mm) Screw Size Hole Size: 9mm Stem Length: 7mm Black Nylon Screw Toyota # 90189-06018</p>  <p>2401 A 25 PCS 2401 B 250 PCS 2401 C 500PCS</p>	<p>2402 #10 (4.8mm) Screw Size Hole Size: 8mm x 8.5mm Stem Length: 8mm Natural Nylon Screw Grommets Honda # 90662-671-0030</p>  <p>2402 A 50 PCS 2402 B 250 PCS 2402 C 500PCS</p>	<p>2403 #8 (4.2mm) Screw Size Hole Size: 5/16" Stem Length: 9/32" Natural Nylon Grille Screw Nuts G.M. # 3919773</p>  <p>2403 A 50 PCS 2403 B 250 PCS 2403 C 500PCS</p>
<p>2404 #8 (4.2mm) Screw Size Hole Size: 7mm Stem Length: 9mm Natural Nylon Radiator Grille Nuts Chrysler # 6000943</p>  <p>2404 A 50 PCS 2404 B 250 PCS 2404 C 500PCS</p>	<p>2405 #8 (4.2mm) Screw Size Hole Size: 5/16" Stem Length: 17/64" Natural Nylon Headlamp Bezel Nuts G.M. # 14013246</p>  <p>2405 A 50 PCS 2405 B 250 PCS 2405 C 500 PCS</p>	<p>2406 GM, Chrysler, VW Screw Size: #6 Headlight Bezel Nuts</p>  <p>2406 A 50 PCS 2406 B 250 PCS 2406 C 500 PCS</p>
<p>2407 #14 (6.3mm) Screw Size Hole Size: 8.5 x 10.5mm Stem Length: 8mm Natural Nylon Screw Grommets Honda # 90656-671-6310M1</p>  <p>2407 A 50 PCS 2407 B 250 PCS 2407 C 500 PCS</p>	<p>2408 Ford Headlight, Door, & Grille #8 Or #10 Screw</p>  <p>2408 A 50 PCS 2408 B 250 PCS 2408 C 500 PCS</p>	<p>2409 Screw Size: #8 Nylon Nuts</p>  <p>2409 A 50 PCS 2409 B 250 PCS 2409 C 500 PCS</p>
<p>2410 GM Headlight, Bezel #6 or #8 Screw Nylon Nuts</p>  <p>2410 A 50 PCS 2410 B 250 PCS 2410 C 500 PCS</p>	<p>2411 Nissan & Mazda Screw Size: #10 Nylon Nuts</p>  <p>2411 A 50 PCS 2411 B 250 PCS 2411 C 500 PCS</p>	<p>2412 Honda, Mazda, & Toyota Use with #10 Screw</p>  <p>2412 A 50 PCS 2412 B 250 PCS 2412 C 500 PCS</p>

PLASTIC GROMMETS		
<p>2413 GM Use with Aveco screw 5307 License Plate Nuts Nylon</p> <p>2413 A 50 PCS 2413 B 250 PCS 2413 C 500 PCS</p>	<p>2414 Honda, Mazda, Mitsubishi, Nissan & Toyota Use with #8 Screw Grommets</p> <p>2414 A 50 PCS 2414 B 250 PCS 2414 C 500 PCS</p>	<p>2415 Use with #12 Tapping Screw Toyota 1992 - On Fender Liner Grommets</p> <p>2415 A 25 PCS 2415 B 250 PCS 2415 C 500 PCS</p>
<p>2416 Screw Size: #12 Fits in 8mm Hole Toyota 1998 - On Screw Grommets</p> <p>2416 A 25 PCS 2416 B 250 PCS 2416 C 500 PCS</p>	<p>2417 #14 (6.3mm) Screw Size Hole Size: 8mm Head: 20mm Stem: 17mm Black Nylon Screw Grommets Toyota # 90189-06013</p> <p>2417 A 25 PCS 2417 B 250 PCS 2417 C 500 PCS</p>	<p>2418 Front Bumper Nylon Nut Use With M5.5 (#12) Head Size: 14MM x 16MM Toyota Camry & Avalon 2002-On (90189-06193)</p> <p>2418 A 25 PCS 2418 B 250 PCS 2418 C 500 PCS</p>
<p>2419 Screw Size: #8 Nylon Nuts</p> <p>2419 A 25 PCS 2419 B 250 PCS 2419 C 500 PCS</p>	<p>2420 #10 (4.8mm) Screw Size Hole Size: 8mm x 9mm Stem Length: 11mm Natural Nylon Headlamp Bezel & Grille Nuts Toyota # 90189-05013</p> <p>2420 A 25 PCS 2420 B 250 PCS 2420 C 500 PCS</p>	<p>2421 Honda Use #14 Screw Nylon Nuts</p> <p>2421 A 25 PCS 2421 B 250 PCS 2421 C 500 PCS</p>
<p>2422 Toyota & Honda Screw Size: 3mm Screw Grommets</p> <p>2422 A 25 PCS 2422 B 250 PCS 2422 C 500 PCS</p>	<p>2423 Mitsubishi, Nissan & Toyota #10 Screw Screw Grommets Nylon</p> <p>2423 A 25 PCS 2423 B 250 PCS 2423 C 500 PCS</p>	<p>2424 GM Headlight Adjusting Nuts</p> <p>2424 A 50 PCS 2424 B 250 PCS 2424 C 500 PCS</p>

Peter: 516-455-6331

Mike: 917-435-2648

Fax: 631- 648-9575

Email: XYZFastenersinc@gmail.com

www.xyzfasteners.com

SCREW GROMMETS			
<p>2425 Screw Size: #12 TOYOTA 1999 - ON Screw Grommets NYLON</p>  <p>2425 A 15 PCS 2425 B 250 PCS 2425 C 500 PCS</p>	<p>2426 Honda Prelude & Accord Headlight Adj. Screw Nuts Nylon</p>  <p>2426 A 25 PCS 2426 B 250 PCS 2426 C 500 PCS</p>	<p>2427 Fits Into 8mm x 11mm Hole Honda Accord, Odyssey & Prelude 1995-99 Bumper Grommets White Nylon</p>  <p>2427 A 50 PCS 2427 B 250 PCS 2427 C 500 PCS</p>	
<p>2428 Fits Onto 5mm Stud Head Diameter: 24mm Hex: 10mm Mercedes Carpet Retainers</p>  <p>2428 A 50 PCS 2428 B 250 PCS 2428 C 500 PCS</p>	<p>2429 FORD 1994-ON Grille & Side Mark Grommets NYLON</p>  <p>2429 A 50 PCS 2429 B 250 PCS 2429 C 500 PCS</p>	<p>2430 GM, Chrysler, VW Screw Size: #6 Headlight Bezel Nuts Nylon</p>  <p>2430 A 50 PCS 2430 B 250 PCS 2430 C 500 PCS</p>	
<p>2431 Screw Size: #6 Ford 1978 - On Grille Attachment Screw Grommets Nylon</p>  <p>2431 A 50 PCS 2431 B 250 PCS 2431 C 500 PCS</p>	<p>2432 GM 1973 - On Headliner Clips Nylon</p>  <p>2432 A 50 PCS 2432 B 250 PCS 2432 C 500 PCS</p>	<p>2433 Nylon "U" Nut #10 (M4.8) Screw Size Panel Range: Up To 1.5mm Center of Hole To Edge: 8mm Nissan & Infiniti 1995-On Nissan & Infiniti 76882-0M000</p>  <p>2433 A 15 PCS 2433 B 250 PCS 2433 C 500 PCS</p>	
<p>2434 Nissan Screw Size: #12 Center Hole To Edge 9Mm Nylon U Nuts</p>  <p>2434 A 15 PCS 2434 B 250 PCS 2434 C 500 PCS</p>	<p>2435 Inner Diameter: 1/4" Outer Diameter: 3/8" Wire Loom Routing Clips Nylon</p>  <p>2435A 15 PCS 2435 B 250 PCS 2435 C 500 PCS</p>	<p>2436 Rear Bumper Screw Grommet Screw Size: M4.8 (No.10) Head Size: 14mm x 14mm Stem Length: 14mm Honda Civic 2009 - On Honda: 90682-SDA-A01</p>  <p>2435 A 15 PCS 2435 B 250 PCS 2435 C 500 PCS</p>	

Peter: 516-455-6331

Mike: 917-435-2648

Fax: 631- 648-9575

Email: XYZFastenersinc@gmail.com

www.xyzfasteners.com

FOLD OVER CLIPS

<p>701</p> <p>Screw Size: M8 - 1.25 14.5mm Hole Center To Edge Extruded U Nuts</p>  <p>701 A 30 PCS 701 B 250 PCS 701 C 500 PCS</p>	<p>702</p> <p>GM & Ford Screw Size: M8 - 1.25 20mm Hole Center To Edge Extruded U Nuts</p>  <p>702 A 30 PCS 702 B 250 PCS 702 C 500 PCS</p>	<p>703</p> <p>10-1.50mm Panel Range: .035" - .232" Center of Hole to Edge: 3/4" Black Finish Extruded "U" Nuts G.M. # 11500662</p>  <p>703 A 10 PCS 703 B 250 PCS 703 C 500 PCS</p>
<p>704</p> <p>Screw Size: #10 Range: .025/.150 Center Hole To Edge: 9/16 U Type Nuts Phosphate</p>  <p>704 A 25 PCS 704 B 250 PCS 704 C 500 PCS</p>	<p>705</p> <p>#8 Screw Range: .025-.125 Hole Center to Edge: 3/8" Spring Type U Nuts</p>  <p>705 A 50 PCS 705 B 250 PCS 705 C 500 PCS</p>	<p>706</p> <p>Screw Size: #14 Range: .025-.125 Center Hole to Edge: 3/8" U Type Nuts</p>  <p>706 A 50 PCS 706 B 250 PCS 706 C 500 PCS</p>
<p>707</p> <p>#8 Screw Pnl. Rng: .025-.15 Hole Center To Edge: 3/8" Spring Type U Nuts</p>  <p>707 A 50 PCS 707 B 250 PCS 707 C 500 PCS</p>	<p>708</p> <p>#8 Screw Range: .025 - .150 Hole Center to Edge: 5/8" Spring Type U Nuts</p>  <p>708 A 50 PCS 708 B 250 PCS 708 C 500 PCS</p>	<p>709</p> <p>Screw Size: #10 Range: .025-.125 Center Hole to Edge: 13/32 U Type Nuts</p>  <p>709 A 50 PCS 709 B 250 PCS 709 C 500 PCS</p>
<p>710</p> <p>5-.80mm Panel Range: .030" - .160" Center of Hole to Edge: 5/8" Black Phosphate Finish Extruded "U" Nuts G.M. # 11500657</p>  <p>710 A 25 PCS 710 B 250 PCS 710 C 500 PCS</p>	<p>711</p> <p>GM M6.3-1.0 Screw Size: M6.3-1.0 13.5mm Hole Center To Edge Extruded U Nuts</p>  <p>711 A 40 PCS 711 B 250 PCS 711 C 500 PCS</p>	<p>712</p> <p>GM M6-1.0 Screw Size 19.5mm Hole Center To Edge Extruded U Nuts</p>  <p>712 A 40 PCS 712 B 250 PCS 712 C 500 PCS</p>

Peter: 516-455-6331

Mike: 917-435-2648

Fax: 631- 648-9575

Email: XYZFastenersinc@gmail.com

www.xyzfasteners.com

FOLD OVER CLIPS		
<p>1107 GM, Ford 5/16" - 18 7/8 Hole Center To Edge Extruded U Nuts</p>  <p>1107 A 15 PCS 1107 B 250 PCS 1107 C 500 PCS</p>	<p>1108 Ford Screw Size: 3/8-16" 3/4 HOLE CENTER To Edge Extruded U Nuts</p>  <p>1108 A 15 PCS 1108 B 250 PCS 1108 C 500 PCS</p>	<p>1109 GM 5/16 - 18 5/8" Hole Center To Edge Extruded U Nuts</p>  <p>1109 A 10 PCS 1109 B 250 PCS 1109 C 500 PCS</p>
<p>1110 GM 1/4 - 20 17/32 Hole Center To Edge Extruded U Nuts</p>  <p>1110 A 25 PCS 1110 B 250 PCS 1110 C 500 PCS</p>	<p>1111 1/4"-20 Panel Range: .010" - .165" Center of Hole to Edge: 25/32" Black Finish Extruded "U" Nuts Ford # 45267</p>  <p>1111 A 25 PCS 1111 B 250 PCS 1111 C 500 PCS</p>	<p>1112 Ford 5/16" - 18 9/16 Hole Center To Edge Extruded U Nuts</p>  <p>1112 A 50 PCS 1112 B 250 PCS 1112 C 500 PCS</p>
<p>1113 GM, Ford 5/16 - 18 Hole: 27/32" Center To Edge Extruded U Nuts Phosphate</p>  <p>1113 A 25 PCS 1113 B 250 PCS 1113 C 500 PCS</p>	<p>1114 GM Thread Size: #10 - 24 15/32 Center Hole To Edge Extruded U Nuts</p>  <p>1114 A 50 PCS 1114 B 250 PCS 1114 C 500 PCS</p>	<p>1115 Lexus 1990- On #10 Screw Center of Hole To Edge: 14Mm U Nuts</p>  <p>1115 A 10 PCS 1115 B 250 PCS 1115 C 500 PCS</p>
<p>1116 Bumper & Fender Apron Nylon "U" Screw Size: M4.8 (#10) Center Of Hole To Edge: 10mm Panel Range: Up To 2mm - On Toyota: 53879-17020</p>  <p>1116 A 15 PCS 1116 B 250 PCS 1116 C 500 PCS</p>	<p>1117 Toyota Use with #14 Screw U Nuts</p>  <p>1117 A 15 PCS 1117 B 250 PCS 1117 C 500 PCS</p>	<p>1118 M4.2 - 1.81 (#8) Thread U Nuts Plated</p>  <p>1118 A 50 PCS 1118 B 250 PCS 1118 C 500 PCS</p>

Peter: 516-455-6331













Mike: 917-435-2648

Fax: 631- 648-9575

Email: XYZFastenersinc@gmail.com

www.xyzfasteners.com

BODY BOLTS & NUTS METRIC

<p>901 M5.5-1.81 x 18mm Outer Diameter: 15mm Hex: 8mm Hex Head Sems Tapping Screws Zinc/Yellow</p>  <p>901 A 25 PCS 901 B 250 PCS 901 C 500 PCS</p>	<p>902 Thread Size: M5-8 Flange Outer Diameter: 11.5mm Hex: 8mm Hex Flange Nuts Blk. Oxide</p>  <p>902 A 50 PCS 902 B 250 PCS 902 C 500 PCS</p>	<p>903 Thread: M5-0.8 Washer O.D: 15mm Hex: 10mm Free Spinning Washer Nuts Phosphate</p>  <p>903 A 25 PCS 903 B 250 PCS 903 C 500 PCS</p>
<p>904 M5 - 0.8 x 20mm 12mm Washer Outer Diameter Hex: 8mm Metric Indented Hex Head Sems Bolts Phosphate</p>  <p>904 A 25 PCS 904 B 250 PCS 904 C 500 PCS</p>	<p>905 Ford; M6-1.0 x 27.5mm Outer Diameter: 19mm (3/4) 8mm Hex Hex Head Sems Bolt W/ Dog Point Black Zinc</p>  <p>905 A 30 PCS 905 B 250 PCS 905 C 500PCS</p>	<p>906 GM M6-1.0 x 20mm Washer Outer Diameter: 17mmHex Head Sems Body Bolts Phosphate</p>  <p>906 A 25 PCS 906 B 250 PCS 906 C 500 PCS</p>
<p>907 M8 - 1.25 Outer Diameter: 19mm Class 8.8 Large Flange Spin Lock Nuts Black Phosphate</p>  <p>907 A 50 PCS 907 B 250 PCS 907 C 500 PCS</p>	<p>908 Thread: M6 - 1.0 Washer Outer Diameter: 16mm Hex: 10mm Free Spinning Washer Nuts Phosphate</p>  <p>908 A 50 PCS 908 B 250 PCS 908 C 500 PCS</p>	<p>909 Thread: M6-1.0 Washer O.D: 20mm Hex: 10mm Free Spinning Washer Nuts Phosphate</p>  <p>909 A 50 PCS 909 B 250 PCS 909 C 500 PCS</p>
<p>910 Thread: M8- 1.25 Washer O.D: 24mm Hex: 13mm Free Spinning Washer Nuts Phosphate</p>  <p>910 A 30 PCS 910 B 250 PCS 910 C 500 PCS</p>	<p>911 M8 - 1.25 Outer Diameter: 17mm Hex: 13mm Gm Hex Flange Nuts Phosphate</p>  <p>911 A 50 PCS 911 B 250 PCS 911 C 500 PCS</p>	<p>912 GM 10mm - 1.5 Washer Outer Diameter:21mm Metric Hex Flange Nuts Phosphate</p>  <p>912 A 25 PCS 912 B 250 PCS 912 C 500 PCS</p>

Peter: 516-455-6331

Mike: 917-435-2648

Fax: 631- 648-9575

Email: XYZFastenersinc@gmail.com

www.xyzfasteners.com

BODY BOLTS METRIC		
<p>913 GM; M8-1.25 x30mm Washer Outer Diameter: 24mm Hex: 13mm</p> <p>913 A 30 PCS 913 B 250 PCS 913 C 500 PCS</p>		<p>914 GM; M10 - 1.5 x 40 mm 28mm Washer Outer Diameter 15mm Hex</p> <p>914 A 10 PCS 914 B 250 PCS 914 C 500 PCS</p>
<p>915 6.3-1.81 x 25mm 24mm O.D. Loose Washer 10mm Indented Hex Head Sheet Metal Screws G.M. # 11507083</p> <p>915 A 30 PCS 915 B 250 PCS 915 C 500 PCS</p>		<p>916 6.3-1.81 x 20mm 17mm O.D. Loose Washer 10mm Indented Hex Washer Head Sheet Metal Screws G.M. # 11505022</p> <p>916 A 50 PCS 916 B 250 PCS 916 C 500 PCS</p>
<p>917 6.3-1.81 x 25mm 11/16" O.D. Loose Washer 10mm Indented Hex Head Sheet Metal Screws G.M. # 11500996</p> <p>917 A 40 PCS 917 B 250 PCS 917 C 500 PCS</p>		<p>918 GM M6-1.0 x 16mm Hex: 10mm Hex Head Sems Body Bolts Cad.</p> <p>918 A 25 PCS 918 B 250 PCS 918 C 500 PCS</p>
<p>919 6-1.00 x 25mm 17mm O.D. Loose Washer 10mm Indented Hex Head Black Finish Metric Type CA Body Bolts G.M. # 11503834</p> <p>919 A 35 PCS 919 B 250 PCS 919 C 500 PCS</p>		<p>920 6-1.00 x 25mm 24mm O.D. Loose Washer 10mm Indented Hex Head Black Finish Metric Type CA Body Bolts G.M. # 11503982</p> <p>920 A 25 PCS 920 B 250 PCS 920 C 500 PCS</p>
<p>921 6-1.00 x 35mm 17mm O.D. Loose Washer 10mm Indented Hex Head Black Finish Metric Type CA Body Bolts G.M. # 11505044</p> <p>921 A 30 PCS 921 B 250 PCS 921 C 500 PCS</p>		<p>922 GM M6-1.0 x 20mm Washer Head: 13mm Black Polyseal Hex Washer Head Body Bolts</p> <p>922 A 50 PCS 922 B 250 PCS 922 C 500 PCS</p>
<p>923 M6 - 1.0 x 25mm Washer Outer Diameter: 23mm Hex: 10mm Hex Head Sems Body Bolts Polyseal</p> <p>923 A 50 PCS 923 B 250 PCS 923 C 500 PCS</p>		<p>924 GM 8 x 1.25 x30mm Hex: 17mm Hex Washer Head Body Bolts Phosphate</p> <p>924 A 25 PCS 924 B 250 PCS 924 C 500 PCS</p>

Peter: 516-455-6331

Mike: 917-435-2648

Fax: 631- 648-9575

Email: XYZFastenersinc@gmail.com

www.xyzfasteners.com

XYZ FASTENERS

BODY BOLTS METRIC

<p>925 M6 - 1.0 x 22mm Washer Outer Diameter: 19mm Hex: 8mm Hex Head Sems Bolt W/ Dog Point Phosphate</p>  <p>925 A 25 PCS 925 B 250 PCS 925 C 500 PCS</p>	<p>926 Ford M6-1.0 x 28mm Washer Outer Diameter: 19mm 8Mm Hex Head Sems Bolts Zinc/Yellow</p>  <p>926 A 25 PCS 926 B 250 PCS 926 C 500 PCS</p>	<p>927 M8-1.25 x 25mm Washer Outer Diameter: 24mm Hex: 13mm Hex Head Sems Body Bolts Phosphate</p>  <p>927 A 25 PCS 927 B 250 PCS 927 C 500 PCS</p>
<p>928 GM M8-1.25 x 25mm Hex: 13mm Metric Hex Washer Head Screws Phosphate</p>  <p>928 A 25 PCS 928 B 250 PCS 928 C 500 PCS</p>	<p>929 M6-1.0 x 30mm 19mm (3/4) Outer Diameter Hex: 10mm Hex Head Sems Body Bolts W/ Dog Point Phosphate</p>  <p>929 A 50 PCS 929 B 250 PCS 929 C 500 PCS</p>	<p>930 M6-1.0 x 20mm Outer Diameter: 24mm Hex: 10mm Hex Head Sems Body Bolts Phosphate</p>  <p>930 A 25 PCS 930 B 250 PCS 930 C 500 PCS</p>
<h2>METRIC BOLTS</h2>		
<p>1101 Ford 1/4-20 x 7/8" Outer Diameter: 3/4" Hex: 7/16"</p>  <p>1101 A 25 PCS 1101 B 250 PCS 1101 C 500 PCS</p>	<p>1102 1/4-20 x 1" Outer Diameter: 5/8" Hex: 7/16" Hex Head Sems Body Bolts Phosphate</p>  <p>1102 A 25 PCS 1102 B 250 PCS 1102 C 500 PCS</p>	<p>1103 5/16 - 18 x 13/16 Hex: 1/2" Hex Washer Head Body Bolts Black Phos</p>  <p>1103 A 25 PCS 1103 B 250 PCS 1103 C 500 PCS</p>
<p>1104 5/16 - 18 x 1" Ford & GM 7/8" Sems Washer Sheet Metal Hex</p>  <p>1104 A 25 PCS 1104 B 250 PCS 1104 C 500 PCS</p>	<p>1105 GM;3/8 - 16 x 1 1" Washer Outer Diameter Hood Hinge To Fender Hex Head Sems</p>  <p>1105 A 15 PCS 1105 B 250 PCS 1105 C 500 PCS</p>	<p>1106 3/8 - 16 x 1-1/2 Hex: 9/16" 1-1/8 Washer Outer Diameter Hex Head Sems</p>  <p>1106 A 15 PCS 1106 B 250 PCS 1106 C 500 PCS</p>

Peter: 516-455-6331

Mike: 917-435-2648

Fax: 631- 648-9575

Email: XYZFastenersinc@gmail.com

www.xyzfasteners.com

SCREWS		
<p>1201 #8 x 1/2" Outer Diameter: 7/16" GM Phillips Washer Hd Tek Tapping Screws Zinc or Black</p>  <p>1201 A 100 PCS 1201 B 250 PCS 1201 C 500 PCS</p>	<p>1202 # 8 x 3/4" Phillips Round Washer Head Tek Tapping Screws Phosphate</p>  <p>1202 A 100 PCS 1202 B 250 PCS 1202 C 500 PCS</p>	<p>1203 M4.2 - 1.41 x 25mm (#8 x 1"); 11mm (7/16); Washer Hd Round Washer Head Tek Tapping Screws</p>  <p>1203 A 100 PCS 1203 B 250 PCS 1203 C 500 PCS</p>
<p>1204 #8 x 1" Phillips Flat Top Washer Head Tapping Screws E- Coat</p>  <p>1204 A 50 PCS 1204 B 250 PCS 1204 C 500 PCS</p>	<p>1205 #10 x 3/4" Phillips Flat Top Washer Head Tapping Screws E-Coat SAME AS 1243</p>  <p>1205 A 50 PCS 1205 B 250 PCS 1205 C 500 PCS</p>	<p>1206 #8 x 3/4" #6 Head Phillips Oval Head Tapping Screws Black Oxide</p>  <p>1206 A 100 PCS 1206 B 250 PCS 1206 C 500 PCS</p>
<p>1207 #10 x 1/2" Hex: 5/16" Hex Washer Head Tek Tapping Screws Zinc</p>  <p>1207 A 50 PCS 1207 B 250 PCS 1207 C 500 PCS</p>	<p>1208 #10 x 3/4" Hex: 5/16" Hex Washer Head Tek Tapping Screws Zinc</p>  <p>1208 A 50 PCS 1208 B 250 PCS 1208 C 500 PCS</p>	<p>1209 MORGAN KNOCKER 'SCREWS #10 x 1-1/2" Hex: 5/16" Hex Head Tapping</p>  <p>1209 A 50 PCS 1209 B 250 PCS 1209 C 500 PCS</p>
<p>1210 #8 x 1/2" Hex: 1/4" Slotted Hex Washer Head Tapping Screws Zinc</p>  <p>1210 A 100 PCS 1210 B 250 PCS 1210 C 500 PCS</p>	<p>1211 M4.2 - 1.41 x 13mm Outer Diameter: 11mm GM Phillips Washer Hd Tapping Screws Black Zinc</p>  <p>1211 A 100 PCS 1211 B 250 PCS 1211 C 500 PCS</p>	<p>1212 GM M4.2-1.41 x 20mm Phillips Was her Head Tapping Screws Black Oxide</p>  <p>1212 A 100 PCS 1212 B 250 PCS 1212 C 500 PCS</p>

Peter: 516-455-6331

Mike: 917-435-2648

Fax: 631- 648-9575

Email: XYZFastenersinc@gmail.com

www.xyzfasteners.com

XYZ FASTENERS

<p>1213 #8 x 1-1/4" #6 Head Phillips Oval Head Tapping Screws Bright Zinc</p>  <p>1213 A 100 PCS 1213 B 250 PCS 1213 C 500 PCS</p>	<p>1214 #8 x 3/4" Phillips Oval Head Tapping Screws Chrome</p>  <p>1214 A 100 PCS 1214 B 250 PCS 1214 C 500 PCS</p>	<p>1215 #8 x 1" #6 Head Phillips Oval Head Tapping Screws Chrome</p>  <p>1215 A 100 PCS 1215 B 250 PCS 1215 C 500 PCS</p>
<p>1216 #14 x 3/4" Head Diameter: 9/16" Slotted Truss Head License Plate Screws</p>  <p>1216 A 50 PCS 1216 B 250 PCS 1216 C 500 PCS</p>	<p>1217 Ford #14 x3/4" Slotted Hex Washer Head License Plate Screws Zinc</p>  <p>1217 A 50 PCS 1217 B 250 PCS 1217 C 500 PCS</p>	<p>1218 #14 x 3/4" Rd. Slotted Truss Head License Plate Screws Black E-Coat</p>  <p>1218 A 100PCS 1218 B 250 PCS 1218 C 500 PCS</p>
<p>1219 #8 x 3/4" #6 Head Phillips Oval Head Sems Tapping Screws Chrome</p>  <p>1219 A 25 PCS 1219 B 250 PCS 1219 C 500 PCS</p>	<p>1220 #8 x 1" #6 Head Phillips Oval Head Sems Tapping Screws Chrome</p>  <p>1220 A 25 PCS 1220 B 250 PCS 1220 C 500 PCS</p>	<p>1221 #8 x 3/8" Ford Phillips Oval Wheel Moulding Screws Zinc</p>  <p>1221 A 100 PCS 1221 B 250 PCS 1221 C 500 PCS</p>
<p>1222 #8 x 1/2" Outer Diameter: 13/32" Phillips Washer Hd Tek Tapping Screws Zinc</p>  <p>1222 A 50 PCS 1222 B 250 PCS 1222 C 500 PCS</p>	<p>1223 M6 - 1.0 x 16mm DIN 7985 Pan Head Metric Machine Screws Zinc</p>  <p>1223 A 50 PCS 1223 B 250 PCS 1223 C 500 PCS</p>	<p>1224 M6 - 1.81 x 20mm Hex: 10mm Phillips Hex Washer Head Tapping Screws Zinc/Yellow</p>  <p>1224 A 50 PCS 1224B 250 PCS 1224 C 500 PCS</p>

Peter: 516-455-6331

Mike: 917-435-2648

Fax: 631- 648-9575

Email: XYZFastenersinc@gmail.com

www.xyzfasteners.com

XYZ FASTENERS

<p>1225 #8 x 1" Phillips Oval Head Tapping Screws Black Oxide</p>  <p>1225 A 100 PCS 1225 B 250 PCS 1225 C 500 PCS</p>	<p>1226 #8 x 3/4" #6 Head Phillips Oval Head Sems Tapping Screws Black Phosphate</p>  <p>1226 A 50 PCS 1226 B 250 PCS 1226 C 500 PCS</p>	<p>1227 #8 x 1" #6 Head Phillips Oval Head Sems Tapping Screws Black Phosphate</p>  <p>1227 A 50 PCS 1227 B 250 PCS 1227 C 500 PCS</p>
<p>1228 M4.2-1.41 x 20mm Washer Outer Diameter: 17mm Hex: 7mm Tapping Screws Phosphate</p>  <p>1228 A 50 PCS 1228 B 250 PCS 1228 C 500 PCS</p>	<p>1229 M4.2-1.41 x 20mm 12mm Washer Outer Diameter Hex: 7mm Hex Head Sems Tapping Screws</p>  <p>1229 A 25 PCS 1229 B 250 PCS 1229 C 500 PCS</p>	<p>1230 #8 x 3/4" Phillips Oval Head Tapping Screws Black Oxide</p>  <p>1230 A 100 PCS 1230 B 250 PCS 1230 C 500 PCS</p>
<p>1231 4.2-1.41 x 20mm 17mm O.D. Loose Washer 7mm Indented Hex Head Sheet Metal Screws G.M. # 11503892</p>  <p>1231 A 50 PCS 1231 B 250 PCS 1231 C 500 PCS</p>	<p>1232 4.2-1.41 x 20mm 12mm O.D. Loose Washer 7mm Indented Hex Head Sheet Metal Screws G.M. # 11503396</p>  <p>1232 A 2 50 PCS 1232 B 250 PCS 1232 C 500 PCS</p>	<p>1233 4.2-1.41 x 20mm 12mm O.D. Loose Washer 7mm Indented Hex Head Tek's Screws</p>  <p>1233 A 25 PCS 1233 B 250 PCS 1233 C 500 PCS</p>
<p>1234 4.8-1.60 x 19mm 16mm O.D. Loose Washer Phillips Truss L/Washer Head Trim Screws Honda # 90114-SE0-000</p>  <p>1234 A 25 PCS 1234 B 250 PCS 1234 C 500 PCS</p>	<p>1235 4.8-1.6 x 15mm 14mm O.D. Washer Head Phillips Truss Head Sheet Metal Screws</p>  <p>1235 A 50 PCS 1235 B 250 PCS 1235 C 500 PCS</p>	<p>1236 6.3-1.81 x 16mm 15mm O.D. Washer Head Phillips Truss Head Sheet Metal Screw</p>  <p>1236 A 50 PCS 1236 B 250 PCS 1236 C 500 PCS</p>
<p>1237 #8 x 1" Phillips Pan Head Tapping Screws Black Oxide</p>  <p>1237 A 100 PCS 1237 B 250 PCS 1237 C 500 PCS</p>	<p>1238 #10 x 1" Phillips Pan Head Tapping Screws Phillips Pan Head Tapping Screws Zinc</p>  <p>1238 A 100 PCS 1238 B 250 PCS 1238 C 500 PCS</p>	<p>1239 #8 x 1" Phillips Pan Head Tapping Screws Phillips Pan Head Tapping Screws Zinc</p>  <p>1239 A 100 PCS 1239 B 250 PCS 1239 C 500 PCS</p>

Peter: 516-455-6331

Mike: 917-435-2648

Fax: 631- 648-9575

Email: XYZFastenersinc@gmail.com

www.xyzfasteners.com

SCREWS		
<p>1240 #10 x 1" Phillips Oval Head Tapping Screws Phillips Oval Head Tapping Screws Chrome</p>  <p>1240 A 100 PCS 1240 B 250 PCS 1240 C 500 PCS</p>	<p>1241 GM M4.21.41 x 16mm 12mm Washer Outer Diameter 7Mm Hex Head Sems Screws Phosphate</p>  <p>1241 A 100 PCS 1241 B 250 PCS 1241 C 500 PCS</p>	<p>1242 10 x 1" Phillips Flat Top Washer Head Tapping Screws E-Coat</p>  <p>1242 A 50 PCS 1242 B 250 PCS 1242 C 500 PCS</p>
<p>1243 #10 x 3/4" Phillips Flat Top Washer Head Tapping Screws E-Coat</p>  <p>1243 A 50 PCS 1243 B 250 PCS 1243 C 500 PCS</p>	<p>1244 #8 x 3/4" #6 Head Phillips Oval Head Tapping Screws Chrome</p>  <p>1244 A 50 PCS 1244 B 250 PCS 1244 C 500 PCS</p>	<p>1245 UNSLOTTED HEXWASHER HEAD BLACK 5/16"X5/8"</p>  <p>1245 A 50 PCS 1245 B 250 PCS 1245 C 500 PCS</p>
<p>1246 UNSLOTTED HEXWASHER HEAD BLACK 14X5/8" (3/8 HD)</p>  <p>1246 A 50 PCS 1246 B 250 PCS 1246 C 500 PCS</p>	<p>1247 Black E-Coat M4.8-1.61 x 20mm (#10 x 25/32") Hex Head Sems 26mm Washer O.D. 8mm Hex Front Bumper & Moulding Strip Mercedes-Benz 2014 - 1993 (Mercedes-Benz: 201-990-05-36)</p>  <p>1247 A 25 PCS 1247 B 250 PCS 1247 C 500 PCS</p>	<p>1248 M4.2- 1.41x20mm Outer Diameter: 16mm Pan Head Sems Tapping Screws Phosphate</p>  <p>1248 A 50 PCS 1248 B 250 PCS 1248 C 500 PCS</p>
<p>1249 #12 x 3/4" Hex: 5/16" Hex Head Tapping Screws Zinc</p>  <p>1249 A 100 PCS 1249 B 250 PCS 1249 C 500 PCS</p>	<p>1250 #12 x 3/4" Phillips Pan Head Tapping Screws Zinc</p>  <p>1250 A 100 PCS 1250 B 250 PCS 1250 C 500 PCS</p>	<p>1251 #8 x 1 Head Outer Diameter: 1/2" Phillips Washer Hd Tapping Screws Phos</p>  <p>1251 A 100 PCS 1251 B 250 PCS 1251 C 500 PCS</p>

Peter: 516-455-6331

Mike: 917-435-2648

Fax: 631- 648-9575

Email: XYZFastenersinc@gmail.com

www.xyzfasteners.com

SCREWS		
<p>1252 #8 x 5/8" #6 Head Phillips Oval Head Sems Tapping Screws Chrome</p>  <p>1252 A 100 PCS 1252 B 250 PCS 1252 C 500 PCS</p>	<p>1253 #14 x 3/4" Phillips Pan Head Tapping Screws Phillips Pan Head Tapping Screws Zinc</p>  <p>1253 A 100 PCS 1253 B 250 PCS 1253 C 500 PCS</p>	<p>1254 #8 x 1-1/4" #6 Head Phillips Oval Head Tapping Screws Black Oxide</p>  <p>1254 A 100 PCS 1254 B 250 PCS 1254 C 500 PCS</p>
<p>1255 #8 x 1-1/4" Phillips Oval Head Tapping Screws Black Oxide</p>  <p>1255 A 100 PCS 1255 B 250 PCS 1255 C 500 PCS</p>	<p>1256 #8 x 3/4" Phillips Pan Head Tapping Screws Black Oxide</p>  <p>1256 A 100 PCS 1256 B 250 PCS 1256 C 500 PCS</p>	<p>1257 #10 x 1" Phillips Oval Head Tapping Screws Black Oxide</p>  <p>1257 A 100 PCS 1257 B 250 PCS 1257 C 500 PCS</p>
<p>1258 #10 x 1" #8 Head Phillips Oval Head Tapping Screws Black Oxid</p>  <p>1258 A 100 PCS 1258 B 250 PCS 1258 C 500 PCS</p>	<p>1259 #8 x 1" #6 Head Phillips Oval Head Sems Tapping Screws Black Phosphate</p>  <p>1259 A 100 PCS 1259 B 250 PCS 1259 C 500 PCS</p>	<p>1260 #10 x 3/4" #8 Head Phillips Oval Head Sems Tapping Screws Black Phosphate</p>  <p>1260 A 100 PCS 1260 B 250 PCS 1260 C 500 PCS</p>
<p>1261 #6 x 1" Phillips Pan Head Tapping Screws Black Oxide</p>  <p>1261 A 100 PCS 1261 B 250 PCS 1261 C 500 PCS</p>	<p>1262 GM M4.2 - 1.41 x 13mm Phillips Washer Head Tapping Screws Zinc</p>  <p>1262 A 100 PCS 1262 B 250 PCS 1262 C 500 PCS</p>	<p>1263 GM #8 x 1/2" Phillips Flat Top Washer Head Tapping Screws E-Coat</p>  <p>1263 A 100 PCS 1263 B 250 PCS 1263 C 500 PCS</p>

Peter: 516-455-6331

Mike: 917-435-2648

Fax: 631- 648-9575

Email: XYZFastenersinc@gmail.com

www.xyzfasteners.com

SCREWS		
<p>1264 #8 x 5/8" Phillips Flat Top Washer Head Tapping Screws E-Coat</p>  <p>1264 A 100 PCS 1264 B 250 PCS 1264 C 500 PCS</p>	<p>1265 #8 X 1-1/4" Phillips Flat Top Washer Head Tapping Screws E-Coat</p>  <p>1265 A 100 PCS 1265 B 250 PCS 1265 C 500 PCS</p>	<p>1266 #8 x 1-1/2" Phillips Flat Top Washer Head Tapping Screws E-Coat</p>  <p>1266 A 100 PCS 1266 B 250 PCS 1266 C 500 PCS</p>
<p>1267 M4-2 - 1.41 x 13mm Pozi-Driv Round Washer Head Tapping Screws Black Oxide</p>  <p>1267A 100 PCS 1267 B 250 PCS 1267 C 500 PCS</p>	<p>1268 GM 1979 - On M4.2 x 10mm Metric Washer Head Tapping Screws Black Oxide</p>  <p>1268 A 100 PCS 1268 B 250 PCS 1268 C 500 PCS</p>	<p>1269 Ford #8 x 3/4" Phillips Washer Head Tapping Screws Phosphate</p>  <p>1269 A 100 PCS 1269 B 250 PCS 1269 C 500 PCS</p>
<p>1270 Chrysler #8 x 1/2" Phillips Washer Head Tapping Screws Zinc</p>  <p>1270 A 100 PCS 1270 B 250 PCS 1270 C 500 PCS</p>	<p>1271 M4.2-1.41 x 16mm GM Phil. Rd. Washer Head Teks Tapping Screws Zinc/Black</p>  <p>1271 A 100 PCS 1271 B 250 PCS 1271 C 500 PCS</p>	<p>1272 Size: #10 x 3/4" Washer Head Outer Diameter: 1/2" Phillips Flat Top Round Washer Head Tapping Screws Black E-Coat</p>  <p>1272 A 100 PCS 1272 B 250 PCS 1272 C 500 PCS</p>
<p>1286 M4.8X16MM HEX HEAD SEMS TAPPING SCREWS</p>  <p>1286 A 50 PCS 1286 B 250 PCS 1286 C 500 PCS</p>	<p>1287 M6.5-1.81 x 18mm Phillips Truss Head Black Phosphate 16mm Head O.D. Fender Liner Hyundai12493-06207B</p>  <p>1287 A 25 PCS 1287 B 250 PCS 1287 C 500 PCS</p>	<p>1288 #8 x 1" #6 Head Phillips Oval Head Tapping Screws Black Oxide</p> 

Peter: 516-455-6331

Mike: 917-435-2648

Fax: 631- 648-9575

Email: XYZFastenersinc@gmail.com

www.xyzfasteners.com

BOLTS & SCREWS		
<p>1273 M8 - 1.25 x35mm Washer: 24mm Outer Diameter; 13mm Hex Metric Indented Hex Head Sems Bolts Phosphate</p> <p>1273 A 25 PCS 1273 B 250 PCS 1273 C 500 PCS</p>		<p>1274 #14 x 7/8" Hex: 3/8" Chrysler Hex Washer Head Tapping Screws Zinc</p> <p>1274 A 25 PCS 1274 B 250 PCS 1274 C 500 PCS</p>
<p>1275 M6-1.0 x 16mm Outer Diameter: 17mm (11/16) Hex: 10mm Hex Head Sems Body Bolts Black</p> <p>1275 A 25 PCS 1275 B 250 PCS 1275 C 500 PCS</p>		<p>1276 M6-1.0 X30mm Washer Outer Diameter: 24mm (15/16) TYPE CA Hex Head Sems Body Bolts Phosphate</p> <p>1276 A 25 PCS 1276 B 250 PCS 1276 C 500 PCS</p>
<p>1277 M5 - 2.12 x 20mm (#12 x 25/32") Head Outer Diameter: 14mm Phillips Truss Head Tapping Screws Phosphate</p> <p>1277 A 25 PCS 1277 B 250 PCS 1277 C 500 PCS</p>		<p>1278 M6.3-1.81x20mm Washer Outer Diameter: 20mm Hex: 10mm Phillips Hex Head Sems Tapping Screws</p> <p>1278 A 25 PCS 1278 B 250 PCS 1278 C 500 PCS</p>
<p>1279 Size: M6-1.0 x 25mm Hex: 10mm Washer Outer Diameter: 19mm Chrysler Hex Head Sems Body Bolts Phosphate</p> <p>1279A 25 PCS 1279 B 250 PCS 1279 C 500 PCS</p>		<p>1280 GM M6.3 - 1.81 x30mm Hex: 10mm Hex Head Sems Body Bolts Phosphate</p> <p>1280 A 50 PCS 1280 B 250 PCS 1280 C 500 PCS</p>
<p>1281 #14 x 3/4" Washer Outer Diameter: 5/8" Hex: 3/8" Hex Head Sems Tapping Screws Zinc</p> <p>1281 A 100 PCS 1281 B 250 PCS 1281 C 500 PCS</p>		<p>1282 #8 x 1/2" Hex: 1/4" Hex Washer Head Tek Tapping Screws Zinc</p> <p>1282 A 100 PCS 1282 B 250 PCS 1282 C 500 PCS</p>
<p>1283 #8 x 3/4" Hex: 1/4" Hex Washer Head Tek Tapping Screws Zinc</p> <p>1283 A 100 PCS 1283 B 250 PCS 1283 C 500 PCS</p>		<p>1284 #10 x 1" Hex: 5/16" Hex Washer Head Tek Tapping Screws Zinc</p> <p>1284 A 100 PCS 1284 B 250 PCS 1284 C 500 PCS</p>
<p>1285 #10 x 1" Hex: 5/16" Hex Washer Head Tek Tapping Screws Zinc</p> <p>1285 A 100 PCS 1285 B 250 PCS 1285 C 500 PCS</p>		<p>1286 #10 x 1" Hex: 5/16" Hex Washer Head Tek Tapping Screws Zinc</p> <p>1286 A 100 PCS 1286 B 250 PCS 1286 C 500 PCS</p>

Peter: 516-455-6331

Mike: 917-435-2648

Fax: 631- 648-9575

Email: XYZFastenersinc@gmail.com

www.xyzfasteners.com

NUT INSERT		
<p>1301 Grip: 7mm-4.2mm Head Diameter: 13mm GM 1993 - On Specialty Inserts Zinc</p>  <p>1301 A 25 PCS 1301 B 250 PCS 1301 C 500 PCS</p>	<p>1302 M5-.8 Thread; Head Diameter: 10mm Grip: .5mm -3.3mm Hex: 7mm Specialty Inserts Zinc</p>  <p>1302 A 25 PCS 1302 B 250 PCS 1302 C 500 PCS</p>	<p>1303 M6-1.0 Range: .030-.165" Metric Thin Sheet Nutserts Steel</p>  <p>1303 A 25 PCS 1303 B 250 PCS 1303 C 500 PCS</p>
DOOR HINGE BUSHING		
<p>1304 5/16" - 18 Thread U.S.S. 1/2" Hole Size Nutserts Tin Plated</p>  <p>1304 A 100 PCS 1304 B 250 PCS 1304 C 500 PCS</p>	<p>1305 Chrysler Vans 1978 - 82 Door Hinge Bushings</p>  <p>1305 A 100 PCS 1305 B 250 PCS 1305 C 500 PCS</p>	<p>1306 GM Trucks Side Door Lower Hinge Door Hinge Bushings</p>  <p>1306 A 100 PCS 1306 B 250 PCS 1306 C 500 PCS</p>
SHIMS		
<p>1401 Thickness: 1/16" Outer Diameter: 15/16" Slot: 3/8" Shims Zinc</p>  <p>1401 A 50 PCS 1401 B 250 PCS 1401 C 500 PCS</p>	<p>1402 Thickness: 1/8" Outer Diameter: 15/16" Slot: 3/8" Shims Zinc</p>  <p>1402 A 50 PCS 1402 B 250 PCS 1402 C 500 PCS</p>	<p>1404 Thickness: 1/16" Slot: 3/8" 1-1/4 x 1-1/8 Shims Zinc</p>  <p>1404 A 50 PCS 1404 B 250 PCS 1404 C 500 PCS</p>
<p>1405 1-1/4" x 1-1/8" Thickness: 1/8" Slot: 3/8"</p>  <p>1405 A 50 PCS 1405 B 250 PCS 1405 C 500 PCS</p> <hr style="border-top: 1px dashed black;"/> <p>1406 1-3/8 x 1-1/4" w/ 5/8" Slot Thickness: 3/16"</p> <p>1406 A 25 PCS 1406 B 250 PCS 1406 C 500 PCS</p>	<p>1417 Thickness: 1/16" 1-1/8 x 1-1/8" Slot: 1/2" Caster & Camber Shims Zinc</p>  <p>1417 A 50 PCS 1417 B 250 PCS 1417 C 500 PCS</p>	<p>1418 Thickness: 1/8" 1-1/8 x 1-1/8" Slot: 1/2" Caster & Camber Shims Zinc</p>  <p>1418 A 50 PCS 1418 B 250 PCS 1418 C 500 PCS</p>

Peter: 516-455-6331

Mike: 917-435-2648













Fax: 631- 648-9575

Email: XYZFastenersinc@gmail.com

www.xyzfasteners.com

XYZ FASTENERS

SHIMS & WASHERS

<p>1403 Bolt Size: 1/4" Inne Diameter: 5/16" Outer Diameter: 3/4" 1/16" Thick Wrought Washers Zinc</p>  <p>1403 A 50 PCS 1403 B 250 PCS 1403 C 500 PCS</p>	<p>1407 Bolt Size: 7/16" Inner Diameter: 15/32" Outer Diameter: 15/16" 1/16" Thick S.A.E. Washers Zinc</p>  <p>1407 A 100 PCS 1407 B 250 PCS 1407 C 500 PCS</p>	<p>1408 Bolt Size: 9/16" Outer Diameter: 1-3/8" U.S.S. High Strength Washers Zinc</p>  <p>1408 A 100 PCS 1408 B 250 PCS 1408 C 500 PCS</p>
<p>1409 Bolt Size: 1/4" Inner Diameter: 9/32" Outer Diameter: 5/8" 1/16" Thick S.A.E. Washers Zinc</p>  <p>1409 A 100 PCS 1409 B 250 PCS 1409 C 500 PCS</p>	<p>1410 Bolt Size: 5/16" Inner Diameter: 11/32" Outer Diameter: 11/16" 1/16" Thick S.A.E. Washers Zinc</p>  <p>1410 A 100 PCS 1410 B 250 PCS 1410 C 500 PCS</p>	<p>1411 Bolt Size: 3/8" Inner Diameter: 13/32" Outer Diameter: 13/16" 1/16" Thick S.A.E. Washers Zinc</p>  <p>1411 A 100 PCS 1411 B 250 PCS 1411 C 500 PCS</p>
<p>1412 Bolt Size: #10 (3/16) Inner Diameter: 7/32" Outer Diameter: 1/2" 1/16" Thick S.A.E. Washers Zinc</p>  <p>1412 A 100 PCS 1412 B 250 PCS 1412 C 500 PCS</p>	<p>1413 Bolt Size: 1/2" Inner Diameter: 17/32" Outer Diameter: 1-1/16" 3/32" Thick S.A.E. Washers Zinc</p>  <p>1413 A 100 PCS 1413 B 250 PCS 1413 C 500 PCS</p>	<p>1414 Bolt Size: 5/16" Inner Diameter: 3/8" Outer Diameter: 7/8" 16" Thick Wrought Washers Zinc</p>  <p>1414 A 100 PCS 1414 B 250 PCS 1414 C 500 PCS</p>
<p>1415 Bolt Size: 3/8" Inner Diameter: 7/16" Outer Diameter: 1" 5/64" Thick Wrought Washers Zinc</p>  <p>1415 A 100 PCS 1415 B 250 PCS 1415 C 500 PCS</p>	<p>1416 Bolt Size: 7/16" Inner Diameter: 1/2" Outer Diameter: 1- 1/4" 5/64" Thick Wrought Washers Zinc</p>  <p>1416 A 100 PCS 1416 B 250 PCS 1416 C 500 PCS</p>	<p>1452 Bolt Size: 1/2" Inner Diameter: 9/16" Outer Diameter: 1-3/8" 7/64 Thick Wrought Washers Zinc</p>  <p>1452 A 100 PCS 1452 B 250 PCS 1452 C 500 PCS</p>

Peter: 516-455-6331



Mike: 917-435-2648

Fax: 631- 648-9575

Email: XYZFastenersinc@gmail.com

www.xyzfasteners.com

SELF THEAD CUTTING NUTS / PUSH NUTS BOLT TETAINERS

<p>1419 Stud Size: 3/16" Washer Outer Diameter: 5/8" Hex: 3/8" Thread Cutting Nuts</p>  <p>1419A 100 PCS 1419 B 250 PCS 1419 C 500 PCS</p>	<p>1420 Stud Size: 1/4" Washer Outer Diameter: 19/32" Hex: 7/16" Thread Cutting Nuts</p>  <p>1420 A 100 PCS 1420 B 250 PCS 1420 C 500 PCS</p>	<p>1421 #8-32 Outer Diameter: 15/32" Hex: 11/32" Washer Lock Nuts Zinc</p>  <p>1421 A 100 PCS 1421 B 250 PCS 1421 C 500 PCS</p>
<p>1422 Stud Size: 5/32" Washer Outer Diameter: 9/16" Hex: 3/8" Thread Cutting Nuts Zinc</p>  <p>1422 A 100 PCS 1422 B 250 PCS 1422 C 500 PCS</p>	<p>1423 Stud Size: 5mm Outer Diameter: 15mm Hex: 10mm Washer Type Self-Threading Nuts Phosphate</p>  <p>1423 A 50 PCS 1423 B 250 PCS 1423 C 500 PCS</p>	<p>1424 Stud Size: 6.3mm Outer Diameter: 18mm Hex: 11mm Washer Type Self-Threading Nuts Zinc</p>  <p>1424 A 50 PCS 1424 B 250 PCS 1424 C 500 PCS</p>
<p>1425 M8 - 1.25 Outer Diameter: 24mm Push nut Bolt Retainers Dachromate</p>  <p>1425 A 50 PCS 1425 B 250 PCS 1425 C 500 PCS</p>	<p>1426 1/2" Bolt Outer Diameter: 15/16" Pushnut Bolt Retainers</p>  <p>1426 A 50 PCS 1426 B 250 PCS 1426 C 500 PCS</p>	<p>1427 M8 - 1.25 Outer Diameter: 15.9mm Pushnut Bolt Retainers Zinc</p>  <p>1427 A 50 PCS 1427 B 250 PCS 1427 C 500 PCS</p>
<p>1119 Ford 3/8" - 16 1-1/8" Hole Center To Edge Extruded U Nut Phosphate</p>  <p>1119 A 15 PCS 1119 B 250 PCS 1119 C 500 PCS</p>	<p>1120 #6 Screw Range: .025 - .125 Center Hole To Edge: 3/8 U Type Nuts</p>  <p>1120 A 50 PCS 112050 PCS 1121500 PCS</p>	<p>713 Screw Size : M4.8 Panel Range : 0.5-1.5MM Center of Hole to Edge : 7MM Finish : Zinc & Yellow</p>  <p>713 A 50 PCS 713 B 250 PCS 713 C 500 PCS</p>

XYZ FASTENERS

<p>1428 Ford Body Belt Moulding & Hood Side Moulding Fastener</p>  <p>1428 A 100 PCS 1428 B 250 PCS 1428 C 500 PCS</p>	<p>1429 Ford & Chrysler Trim Panel Fasteners</p>  <p>1429 A 100 PCS 1429 B 250 PCS 1429 C 500 PCS</p>	<p>1430 WIRE MOULDING CLIP-3/4' CHRYSLER</p>  <p>1430 A 100 PCS 1430 B 250 PCS 1430 C 500 PCS</p>
<p>1444 Ford 1966 - On Window Reveal Moulding Clips</p>  <p>1444 A 100 PCS 1444 B 250 PCS 1444 C 500 PCS</p>	<p>1445 GM 1967 - On Window Reveal Moulding Clips</p>  <p>1445 A 100 PCS 1445 B 250 PCS 1445 C 500 PCS</p>	<p>1446 GM Trucks 1993 - On Screw Size: #8 Radiator Grille Nuts Zinc Phosphate</p>  <p>1446 A 25 PCS 1446 B 250 PCS 1446 C 500 PCS</p>
<p>1447 Groove 75; 2 Sided Primary Resistor Valve 5 Previous # 18785 Gm Vats Key Blank</p>  <p>1447 A 25 PCS 1447 B 250 PCS 1447 C 500 PCS</p>	<p>1448 #10-24 x 1/2" Universal Moulding Fasteners</p>  <p>1448 A 15 PCS 1448 B 250 PCS 1448 C 500 PCS</p>	<p>1449 STEEL COTTER PINS 5/32"X 2"</p>  <p>1449 A 15 PCS 1449 B 250 PCS 1449 C 500 PCS</p>
<p>1450 GM & Ford Tube Size: 1/4" Vacuum Caps Rubber</p>  <p>1450 A 25 PCS 1450 B 250 PCS 1450 C 500 PCS</p>	<p>1451 TOYOTA1982-ON BUMPER CLIPS</p>  <p>1451 A 25 PCS 1451 B 250 PCS 1451 C 500 PCS</p>	<p>419 Medium For Cushion Springs Hog Rings</p>  <p>419 A 100 PCS 419 B 250 PCS 419 C 500 PCS</p>

Peter: 516-455-6331

Mike: 917-435-2648

Fax: 631- 648-9575

Email: XYZFastenersinc@gmail.com

www.xyzfasteners.com

CABLE TIES STRAPS

1453

**30" BLACK CABLE TIES
HEAVY DUTY
250 LB. TEST
25 PCS**



1456

**14" BLACK CABLE TIES
100A PCS
500CPCS
1000DPCS**



1440

**CABLE length: 140mm (5-1/2)
Honda & Mazda
Releasable Cable Straps¹⁴²⁹⁸
1440 A 25 PCS
1440 B 250 PCS
1440 C 500 PCS**



1441

**200mm (8") Long
Max. Bundle Diameter: 44mm (1-3/4")
Cable Straps #20380
Nylon
1441 A 25 PCS
1441 B 250 PCS
1441 C 500 PCS**



1442

**11" BLACK CABLE TIES
11" WHITE CABLE TIES**















**1442 A 100PCS
1442 C 500 PCS**



1443

**7" BLACK CABLE TIES
1443 A 100 PCS
1443 C 500 PCS**



Aluminum Rivet & Mandrel Blind Rivets		
<p>1501 Diameter: 3/16" Grip: Up to 3/8"</p>  <p>1501 A 50 PCS 1501 B 250 PCS 1501 C 500 PCS</p>	<p>1502 Diameter: 3/16" Grip: Up to -5/8"</p>  <p>1502 A 50 PCS 1502 B 250 PCS 1502 C 500 PCS</p>	<p>1503 Diameter: 3/16" Grip: Up To 1/2</p>  <p>1503 A 50 PCS 1503 B 250 PCS 1503 C 500 PCS</p>
<p>1504 Diameter: 5/32" Grip: Up to 1/4"</p>  <p>1504 A 100 PCS 1504 B 250 PCS 1504 C 500 PCS</p>	<p>1505 Diameter: 3/16" Grip: Up To 1/8</p>  <p>1505 A 50 PCS 1505 B 250 PCS 1505 C 500 PCS</p>	<p>1506 Diameter: 3/16" Grip: Up To 1/4"</p>  <p>1506 A 50 PCS 1506 B 250 PCS 1506 C 500 PCS</p>
<p>1507 Diameter: 1/8" Grip: Up To 1/8" Dome Head;</p>  <p>1507 A 100 PCS 1507 B 250 PCS 1507 C 500 PCS</p>	<p>1508 1/8" 23/64" 1/4" Dome 3/16" - 1/4" Alum/Alum</p>  <p>1508 A 100 PCS 1508 B 250 PCS 1508 C 500 PCS</p>	<p>1509 Diameter: 1/8" Grip: Up To 1/4</p>  <p>1509 A 100 PCS 1509 B 250 PCS 1509 C 500 PCS</p>
<p>1510 Diameter: 1/8" Grip Up to 1/2"</p>  <p>1510 A 100 PCS 1510 B 250 PCS 1510 C 500 PCS</p>	<p>1511 Diameter: 1/8" Grip: Up to 3/8" Aluminum Rivet & Mandrel</p>  <p>1511 A 100 PCS 1511 B 250 PCS 1511 C 500 PCS</p>	<p>1512 Diameter: 1/8" Grip: Up To 3/8</p>  <p>1512 A 100 PCS 1512 B 250 PCS 1512 C 500 PCS</p>
<p>1516 Diameter: 3/16" Grip: Up to 3/8" Large Flange Head; All Aluminum Blind Rivets</p>  <p>1516 A 50 PCS 1516 B 250 PCS 1516 C 500 PCS</p>	<p>1517 Diameter: 3/16" Grip: 3/8 - 1/2" Large Flange Aluminum Rivet & Mandrel Blind Rivet</p>  <p>1517 A 50 PCS 1517 B 250 PCS 1517 C 500 PCS</p>	<p>1518 Diameter: 1/8" Grip: Up To 1/4" Dome Head; All Steel Blind Rivets</p>  <p>1518 A 100 PCS 1518 B 250 PCS 1518 C 500 PCS</p>

Peter: 516-455-6331













Mike: 917-435-2648

Fax: 631- 648-9575

Email: XYZFastenersinc@gmail.com

www.xyzfasteners.com

BLIND RIVETS ALL ALUMINIUM

<p>1519 Diameter: 1/8" Grip: Up to 1/8" All Aluminum Blind Rivets</p>  <p>1519 A 100 PCS 1519 B 250 PCS 1519 C 500 PCS</p>	<p>1515 4mm Hole Size Grip Range: 1.2mm - 3.4mm Flange Diameter: 6mm Alum. Rivet Steel Mandrel Nylon Capped Pop Rivets Lexus # 90269-04051</p>  <p>1515 A 15 PCS 1515 B 250 PCS 1515 C 500 PCS</p>	<p>1537 5mm Hole Size Grip Range: 3mm - 8mm Flange Diameter: 14mm Alum. Rivet Steel Mandrel Nylon Capped Pop Rivets Toyota # 90269-05054</p>  <p>1537 A 15 PCS 1537 B 250 PCS 1537 C 500 PCS</p>
<p>1538 5mm Hole Size Grip Range: 4mm - 7mm Flange Diameter: 13mm Alum. Rivet Steel Mandrel Nylon Capped Pop Rivets Lexus # 90269-05065</p>  <p>1538 A 15 PCS 1538 B 250 PCS 1538 C 500 PCS</p>	<p>1539 1/8 (3.2mm) Diameter Grip: 3/64-3/16" (1mm - 4.8mm) Toyota 1998-On Specialty Rivets</p>  <p>1539 A 10 PCS 1539 B 250 PCS 1539 C 500 PCS</p>	<p>1540 1/8 (3.2mm) Diameter Grip: 5/32-5/16" (4mm - 8mm) Lexus 1998-On Specialty Rivets</p>  <p>1540 A 15 PCS 1540 B 250 PCS 1540 C 500 PCS</p>
<p>1541 4mm Hole Size Grip Range: 1.2mm - 4mm Flange Diameter: 9mm Alum. Rivet Steel Mandrel Nylon Capped Pop Rivets Toyota # 90269-04006</p>  <p>1541 A 10 PCS 1541 B 250 PCS 1541 C 500 PCS</p>	<p>1542 6mm Hole Size Grip Range: 1.6mm - 6.35mm Flange Diameter: 13.5mm Capped Pop Rivets Toyota # 90269-06013</p>  <p>1542 A 25 PCS 1542 B 250 PCS 1542 C 500 PCS</p>	<p>1543 Diameter: 5/32" Grip: 3/64 -1/4" All Chrysler 1999-On Rivets</p>  <p>1543 A 25 PCS 1543 B 250 PCS 1543 C 500 PCS</p>
<p>1544 Split-Type Rivets 5/32 (4mm) Dia. Grip: 1mm-7mm Mercedes-Benz 2004-On Mercedes-Benz 003-990-94-97</p>  <p>1544 A 25 PCS 1544 B 250 PCS 1544 C 500 PCS</p>	<p>1545 Diameter: 3/64" Grip: 3/64" - 15/32" All Aluminum Black; Gm 1990-On Specialty Rivets</p>  <p>1545 A 25 PCS 1545 B 250 PCS 1545 C 500 PCS</p>	<p>1546 Diameter: 1/4" Grip: 3/64" -1/4" Ford 96 -On Split-Type Rivets</p>  <p>1546 A 15 PCS 1546 B 250 PCS 1546 C 500 PCS</p>













Peter: 516-455-6331

Mike: 917-435-2648

Fax: 631- 648-9575

Email: XYZFastenersinc@gmail.com

www.xyzfasteners.com

RIVETS		
<p>1525 Ford 1981 - On Diameter 1/4" Grip: 1/8 - 1/4 Steel Mandrel Rivets</p>  <p>1525 A 30 PCS 1525 B 250 PCS 1525 C 500 PCS</p>	<p>1526 Ford, Chrysler, GM Diameter: 1/4" Grip: 1/32 - 9/64 Window Regulator Peel Type Rivets</p>  <p>1526 A 50 PCS 1526 B 250 PCS 1526 C 500 PCS</p>	<p>1527 Ford, GM, Chrysler Diameter: 1/4" Grip: 33/64-19/32 Window Regulator Peel Type Rivets</p>  <p>1527 A 50 PCS 1527 B 250 PCS 1527 C 500 PCS</p>
<p>1528 Diameter: 1/4" Grip: 3/64" - 5/64" All Steel; Gm Trucks; 1998-On Specialty Rivets Zinc</p>  <p>1528 A 15 PCS 1528 B 250 PCS 1528 C 500 PCS</p>	<p>1529 Diameter: 5/32" (4mm) Grip: 1/8-11/32" (3mm- 8.5mm) All Aluminum Specialty Rivets</p>  <p>1529 A 25 PCS 1529 B 250 PCS 1529 C 500 PCS</p>	<p>1530 Diameter: 5/32" Grip: 3/64-1/4" All Black Aluminum Lincoln 1994 - On Specialty Rivets</p>  <p>1530 A 25 PCS 1530 B 250 PCS 1530 C 500 PCS</p>
<p>1531 Diameter: 1/8" Grip: 1/8 -3/16 Ford Windshield Side Rail Aluminum Rivet</p>  <p>1531A 50 PCS 1531B 250 PCS 1531C 500 PCS</p>	<p>1532 GM Diameter: 3/16" 3/8" Grip Special Rivets</p>  <p>1532 A 50 PCS 1532 B 250 PCS 1532 C 500 PCS</p>	<p>1533 Diameter: 3/16" Grip: 3/8 - 1/2 All Aluminum Ford Specialty Rivets</p>  <p>1533 A 40 PCS 1533 B 250 PCS 1533 C 500 PCS</p>
<p>1534 Diameter: 3/16" 5/16" - 15/64" Grip Split-Type Rivets</p>  <p>1534 A 25 PCS 1534 B 250 PCS 1534 C 500 PCS</p>	<p>1535 Diameter: 1/4" Grip: 3/16 -3/8 Bl. Alum. Rivet & Mandrel Specialty Rivets</p>  <p>1535 A 25 PCS 1535 B 250 PCS 1535 C 500 PCS</p>	<p>1536 Ford Diameter: 1/4" Grip: 3/32 - 1/8 Window Regulator Peel</p>  <p>1536 A 25 PCS 1536 B 250 PCS 1536 C 500 PCS</p>

Peter: 516-455-6331











Mike: 917-435-2648

Fax: 631- 648-9575

Email: XYZFastenersinc@gmail.com

www.xyzfasteners.com

XYZ FASTENERS

RIVETS		
<p>1552 Diameter: 3/16" Grip: 1/4-3/8" All Alum.(Black) GM Mini-Vans 1995 - On Specialty Rivet</p>  <p>1552 A 50 PCS 1552 B 250 PCS 1552 C 500 PCS</p>	<p>1553 Diameter: 1/8" Grip: 13/64-9/32 All Black Alum. Dome Head Closed-End Rivets</p>  <p>1553 A 50 PCS 1553 B 250 PCS 1553 C 500 PCS</p>	<p>1554 Diameter: 1/4" Grip: 9/64 -3/16 Window Regulator Peel Type Rivets</p>  <p>1554 A 25 PCS 1554 B 250 PCS 1554 C 500 PCS</p>
<p>1555 GM; 1/4" Diameter 1/2" Flange O.D Aluminum Rivet, Steel Mandrel Window Reg. Rivets</p>  <p>1555 A 10 PCS 1555 B 250 PCS 1555 C 500 PCS</p>	<p>1556 Diameter: 1/4" Grip: 11/16 -3/4 Window Regulator Peel Type Rivets</p>  <p>1556 A 25 PCS 1556 B 250 PCS 1556 C 500 PCS</p>	<p>1562 Diameter: 5/32" Grip: Up to 1/8" All Aluminum</p>  <p>1562 A 25 PCS 1562 B 250 PCS 1562 C 500 PCS</p>
Steel Mandrel Specialty		
<p>1549 GM APV Vans Diameter: 3/16" Moulding Attach.'</p>  <p>1549 A 25 PCS 1549 B 250 PCS 1549 C 500 PCS</p>	<p>1550 Diameter: 5/32" 1/4 -3/8 Grip Special Rivets</p>  <p>1550 A 25 PCS 1550 B 250 PCS 1550 C 500 PCS</p>	<p>1551 1/8 DIA Grip: 1/16-1/8" ALUM RIVET Steel Mandrel Specialty</p>  <p>1551 A 50 PCS 1551 B 250 PCS 1551 C 500 PCS</p>
<p>1565 Diameter: 5/32" Grip: 1/8 -3/16 Aluminum Rivet Steel Mandrel Specialty Rivets</p>  <p>1565 A 25 PCS 1565 B 250 PCS 1565 C 500 PCS</p>	<p>1566 Diameter: 1/8" Grip: .125-.187; Flange Outer Diameter: .375 Alum. Rivet, St. Mandrel Large Flange Rivets</p>  <p>1566 A 100 PCS 1566 B 250 PCS 1566 C 500 PCS</p>	<p>1567 GM 1990-ON SPLIT TYPE RIVETS</p>  <p>1567 A 15 PCS 1567 B 250 PCS 1567 C 500 PCS</p>













Peter: 516-455-6331

Mike: 917-435-2648

Fax: 631- 648-9575

Email: XYZFastenersinc@gmail.com

www.xyzfasteners.com

PLASTIC RIVETS (Nylon Blind Rivets Black)		
<p>1513 GM, Ford & Chry. Diameter: 1/4" Grip: 5/32 - 13/32</p>  <p>1513 A 30 PCS 1513 B 250 PCS 1513 C 500 PCS</p>	<p>1514 15/64" (6mm) Hole Size 20mm Flange Size 2.5mm - 4.8mm Grip Range Black BMW #51-71-7-002-953-2</p>  <p>1514 A 15 PCS 1514 B 250 PCS 1514 C 500 PCS</p>	<p>1520 GM & VW Diameter: 13/64" Grip: 1/8 - 15/64</p>  <p>1520 A 50 PCS 1520 B 250 PCS 1520 C 500 PCS</p>
<p>1521 Chrysler Diameter: 13/64" Grip: 15/64- 25/64</p>  <p>1521 A 50 PCS 1521 B 250 PCS 1521 C 500 PCS</p>	<p>1522 17/64" (6.74mm) Hole Size Grip Range: 3/32" - 3/16" Flange Diameter: 1/2" G.M. # 20421672</p>  <p>1522 A 30 PCS 1522 B 250 PCS 1522 C 500 PCS</p>	<p>1523 17/64" (6.74mm) Hole Size Grip Range: 3/32" - 3/16" Flange Diameter: 23/32" G.M. # 20433026</p>  <p>1523 A 30 PCS 1523 B 250 PCS 1523 C 500 PCS</p>
<p>1524 GM & Ford Diameter: 1/4" Grip: 5/32 - 13/32</p>  <p>1524 A 50 PCS 1524 B 250 PCS 1524 C 500 PCS</p>	<p>1547 GM Diameter: 9/32" Grip: 3/32 - 15/64</p>  <p>1547 A 25 PCS 1547 B 250 PCS 1547 C 500 PCS</p>	<p>1548 Diameter: 1/4 Grip: 5/16 - 15/32</p>  <p>1548 A 25 PCS 1548 B 250 PCS 1548 C 500 PCS</p>
<p>1557 GM Diameter: 5/64" Grip: 5/32 - 5/16" Nylon Blind Rivets</p>  <p>1557 A 25 PCS 1557 B 250 PCS 1557 C 500 PCS</p>	<p>1558 Diameter: 1/4" Grip: 5/32 - 3/8" Jeep & Dodge Nylon Rivets Black Nylon</p>  <p>1558 A 25 PCS 1558 B 250 PCS 1558 C 500 PCS</p>	<p>1559 GM Diameter: 15/64" Grip: 11/64-11/32 Nylon Blind Rivets Black</p>  <p>1559 A 25 PCS 1559 B 250 PCS 1559 C 500 PCS</p>









Peter: 516-455-6331

Mike: 917-435-2648

Fax: 631- 648-9575

Email: XYZFastenersinc@gmail.com

www.xyzfasteners.com

RIVETS		
<p>1557 GM 1 Diameter: 5/64" Grip: 5/32 - 5/16" Nylon Blind Rivets</p>  <p>1557 A 25 PCS 1557 B 250 PCS 1557 C 500 PCS</p>	<p>1558 Diameter: 1/4" Grip: 5/32 -3/8" Jeep & Dodge Nylon Rivets Black Nylon</p>  <p>1558 A 25 PCS 1558 B 250 PCS 1558 C 500 PCS</p>	<p>1559 GM Diameter: 15/64" Grip: 11/64-11/32 Nylon Blind Rivets Black</p>  <p>1559 A 25 PCS 1559 B 250 PCS 1559 C 500 PCS</p>
<p>1560 Diameter: 3/16"; Grip: 5/32 - 1/4" Dodge Daytona Black Nylon Rivets</p>  <p>1560 A 25 PCS 1560 B 250 PCS 1560 C 500 PCS</p>	<p>1561 GM Diameter: 13/64" Grip: 1/16-11/64 Nylon Blind Rivets Black</p>  <p>1561 A 25 PCS 1561 B 250 PCS 1561 C 500 PCS</p>	<p>1564 Nylon Rivet 1/4" (6.3mm) Diameter Grip Range: 5/32"-3/8" (4mm-10mm) Flange Diameter: 21/32" (16.5mm)GM 15614746 Black</p>  <p>1564 A 25 PCS 1564 B 250 PCS 1564 C 500 PCS</p>
<p>1568 Diameter: 1/8" Grip: 5/16-3/8 Aluminum Rivet Steel Mandrel Moulding Rivets</p>  <p>1568 A 50 PCS 1568 B 250 PCS 1568 C 500 PCS</p>	<p>1569</p>	<p>1570 Special Rivet Ford 1/4" Diameter 1/2" Flange Diameter</p>  <p>1570 A 25 PCS 1570 B 250 PCS 1570 C 500 PCS</p>













**HEX SLOTTED SCREW-WORM GEAR TYPE
HOSE CLAMPS
ALL STAINLESS STEEL**



























1439













PART#	SIZE	RANGE	PCS
1431	4	mini ¼ - maximum	10
1432	6	mini ½ - maximum	10
1433	8	7/16 - 1" Ind. Std. Stainless	10
1434	10	1/2 - 1-1/8 Ind. Std. Stainless	10
1435	12	1/2 - 1-1/4" Ind. Std. Stainless	10
1436	20	¾-1-3/4" Ind. Std. Stainless	10
1437	24	1"-2" Ind. Std. Stainless	10
1438	28	1-5/16"-2-1/4" Ind. Std. Stainless	10
1439	32	1-9/16"-2-1/2" Ind. Std. Stainless	10

ASSORTMENT

SOURCE AUTO BODY FASTENERS					
NISSAN RETAINERS 125 PCS			#20101		
 16725 Nissan Push-Type Retainer 12mm x 18mm Head	 16859 Nissan Flange Outer Diameter: 14mm 16mm Stem Length Cowal Panel Retainers	 16784 Nissan Flange Diameter: 18mm Fits 2mm Hole Push-Type Retainers	 17347 Nissan Head Diameter: 20mm Fits 8mm Hole Bumper Cover Retainers	 19274 Nissan Fits Into 8mm Hole Nissan Front Fender Push-Type Retainers	 20348 Nissan Head Diameter: 20mm Stem Length: 22mm Fits Into 8mm Hole Nissan 1994 - On Push-Type Retainers
 16858 Nissan Head Diameter: 20mm Stem Length: 18mm Fits In 8mm Hole Shield Retainers	 19246 Nissan Flange Outer Diameter: 15mm Fits 10mm Hole Nissan 1994-On Push-Type Retainers	 17378 Nissan Head Diameter: 22mm Fits In 11mm Hole Bumper & Fascia Push-Type Retainers	 13945 Door Trim Panel Retainer	 14353 Nissan Head Diameter: 14mm Fits Into 6mm Hole Retaining Clips	 17237 Nissan 1981 - On Outer Diameter: 28mm Stem Length: 9mm Hood Insulation Retainers

SOURCE AUTO BODY FASTENERS					
TOYOTA RETAINERS 146 PCS			#2011A		
 14269 Mazda:9927-40-825) Toyota Trim Panel Retainers	 14260 Toyota & Mazda Fits 7mm Hole Push-Type Retainers	 18888 Toyota & Mazda Head Diameter: 20mm Fits Into 7mm Hole Toyota 1994 - On Front Fender Liner Push-Type Retainers	 18873 Toyota Head Diameter: 18mm Stem Length: 28mm Fits 9mm Hole Toyota Push-Type Retainers	 18297 Toyota Head Diameter: 13mm Fits: 5mm Hole Retaining Clips	 14738 Toyota Head Diameter: 30mm Fits Into 7mm Hole Retaining Clips Nylon
 14274 Honda, Mazda, & Toyota Head with #10 Screw Nylon Nuts	 13932 Toyota Screw Size: 5mm Screw Grommets Nat. Nylon	 14275 Mitsubishi, Nissan & Toyota Head Diameter: 20mm Fits Into 6mm Hole Screw Grommets Nylon	 19721 Toyota Screw Size: #12 Tapping Screw Fits In 8mm Hole Toyota 1996 - On Screw Grommets Black Nylon	 19194 Toyota Head Diameter: 13mm Use with #12 Tapping Screw Fender Liner Grommets Nylon	 14267 Toyota Head Diameter: 30mm Use with #14 Screw Retaining Clips Nylon

SOURCE AUTO BODY FASTENERS					
NISSAN RETAINERS 125 PCS			#2010 A		
 14953 Ford Fascia, Trim & Grille Attachment Retainers	 16859 Nissan Flange Outer Diameter: 14mm 16mm Stem Length Cowal Panel Retainers	 16784 Nissan Flange Diameter: 18mm Fits 7mm Hole Push-Type Retainers	 17347 Nissan Head Diameter: 20mm Fits 8mm Hole Bumper Cover Retainers	 19274 Nissan Fits Into 8mm Hole Nissan 1994 - On Front Fender Push-Type Retainers	 20348 Nissan Head Diameter: 20mm Stem Length: 22mm Fits Into 8mm Hole Nissan 1994 - On Push-Type Retainers
 16858 Nissan Head Diameter: 20mm Stem Length: 18mm Fits In 8mm Hole Shield Retainers	 19246 Nissan Flange Outer Diameter: 15mm Fits 10mm Hole Nissan 1994-On Push-Type Retainers	 17378 Nissan Head Diameter: 22mm Fits In 11mm Hole Bumper & Fascia Push-Type Retainers	 16000 Honda, Mazda, & Nissan Head Diameter: 14mm Fits In 8mm Hole Head Retainers	 14353 Nissan Head Diameter: 14mm Fits Into 6mm Hole Retaining Clips	 17237 Nissan 1981 - On Outer Diameter: 28mm Stem Length: 9mm Hood Insulation Retainers

SOURCE AUTO BODY FASTENERS					
HONDA RETAINERS 125 PCS			#2009A		
 17143 Honda Head Diameter: 20mm Stem Length: 27mm Fits 10mm Hole; Honda 1990 - On Push-Type Retainers	 17144 Honda Head Diameter: 20mm Stem Length: 24mm Fits In 10mm Hole Push-Type Retainers	 17267 Honda Head Diameter: 20mm Push-Type Bumper Retainers Nylon	 17057 Honda Head Diameter: 18mm Stem Length: 21mm Fits In 8mm Hole Push-Type Retainers	 17379 Honda Accord 1990 - On Head Diameter: 20mm Fits In 8mm Hole	 18877 Honda Head Diameter: 20mm Fits 10mm Hole Accra 3.5L 1996-On Push-Type Retainers
 19233 Honda Head Diameter: 20mm Fits 10mm Hole Accra 3.5L 1996-On Push-Type Retainers	 18119 Honda 1990 - On Head Diameter: 20mm Fits In 10mm Hole Push-Type Bumper Retainers	 19239 Honda Head Diameter: 20mm Fits In 8mm Hole Accra & Honda Front Fender Push-Type Retainers	 20564 Honda Head Diameter: 20mm Fits In 10mm Hole Accra & Honda 1996-On Push-Type Retainers	 19114 Honda Head Diameter: 12mm Stem Length: 9mm Accra & Honda Hooding Retaining Clips	 18746 Honda Head Diameter: 20mm Stem Diameter: 10mm Stem Length: 6mm Accra 1991 - On Hood Insulation Retainers

Peter: 516-455-6331

Mike: 917-435-2648

Fax: 631- 648-9575

Email: XYZFastenersinc@gmail.com

www.xyzfasteners.com

ASSORTMENT

SOURCE AUTO BODY FASTENERS					
ROCKER PANEL MOULDING CLIPS 116PCS KIT# 2056					
19822 GM 1995 - On Rocker Panel Moulding Clips	19820 999 - On Rocker Panel Moulding Clips W. Nylon	19821 •Chevrolet •2000 - On •Rocker Panel Moulding Clips •G. Nylon	20328 •Chevrolet •2000 - On •Rocker Panel Moulding Clips •Nylon	20481 •Ford: Airtack & •GM C.A.K Trucks •2001 - On •Moulding Clips •Nylon	20607 •Top Head Size: 12mm x 20mm •Bottom •2004 - On •Moulding Clips •Nylon
19800 •Head Size: •15/32 x 1-5/16" •fits in 5/16 Hole; GM •2000 - On •Moulding Clips •Nylon	20756 GM Moulding Clip	20774 Moulding Clip - GM	20808 GM Moulding Clip	20377 GM Avalanche 2002 - On Moulding Clips Nylon	20884 •Chevrolet Equinox & •Pontiac Torrent 2002 - On •O/E# 11561491, 15822008 •Black Nylon

SOURCE AUTO BODY FASTENERS					
IMPORT FENDER FLARE, GARNISH MOULDING & DOOR TRIM PANEL RETAINERS ASSORTMENT 2024P					
20576 Top Hd: 10 x 13mm Screw Diameter: 8mm; Screw Length: 9mm Ford & Toyota 2002-On	20633 Head Diameter: 13mm, 16mm & 18mm Stem Length: 13mm Toyota 2004 - On Ford Rotators	20588 Top Hd Diameter: 13mm Stem Diameter: 10mm Lexus & Toyota 2000 - On	19109 Lg. Head Diameter: 16mm Stem Diameter: 9mm Toyota Trim Panel Retainers	16778 Mazda & Toyota Trim Panel Retainers Trim Panel Retainers	20575 Top Head Diameter: 13mm Stem Length: 13mm Toyota & Lexus 90 On
21070 Trim Panel Retainer Top Head Diameter: 13mm Middle Head Diameter: 16mm Bottom Head Diameter: 16mm Stem Diameter: 9.5mm Stem Length: 13mm Chrysler Acura 2004	20959 Door Panel Retainer Top Head Diameter: 13mm Middle Head Diameter: 16mm Bottom Head Diameter: 16mm Stem Diameter: 9.5mm Stem Length: 13mm	21087 Cowl Vent & Radiator Support Retainer Top Head Diameter: 13mm Middle Head Diameter: 16mm Bottom Head Diameter: 16mm Stem Diameter: 9.5mm Stem Length: 13mm Honda CRV & Fit 2000 - On Orange Nylon	10576 SHIMMERS SIZE TOP HEAD DIAMETER: 12.5MM STEM LENGTH: 14.5MM NISSAN ORANGE NYLON WITH SEALER DOOR TRIM PANEL RETAINER	20459 DOOR TRIM PANEL RETAINER 16MM STEM LENGTH Head Diameter: 16mm & 18mm Mazda 2008 - On Trim Panel	20932 Door Trim Panel Retainer With Sealer Top Head Diameter: 14mm Bottom Head Diameter: 16mm Stem Length: 14mm Mazda 3.5, CX-7, Mini & Proton 2001 On Mazda GM 08-05-02 White

SOURCE AUTO BODY FASTENERS					
TOYOTA & LEXUS MOULDING CLIPS 154 PCS #2023A					
17481 •Toyota Previa & Estima •1990 - On •Rocker Panel Moulding Clips •Nylon	20390 •Toyota •2001 - On •Moulding Clips •Blue Nylon	20391 •Toyota •2001 - On •Moulding Clips •Red Nylon	19797 •Toyota •1998 - On •Moulding Clips •Nylon	14264 •Toyota •Length: 14mm •Width: 20mm •Moulding Clips •Nylon	20429 •Fender & Wheel Flare •Toyota •2002 - On •Moulding Clips •Nylon
20687 BLUE NYLON Rocker Moulding With Sealer •Head Diameter: 17 mm Stem Length: 10mm Previa 1990-on	20688 Moulding Clip w/ Sealer Orange Toyota	15695 •Toyota Truck •Hinge Diameter: 15mm •Fits Into 8mm Hole •Moulding Clips •Nylon	19843 •Head Diameter: 20mm •Stem Length: 20mm •Toyota RAV 4 1996 - On •Garnish Clips	20876 •Rocker Moulding Clip w/ Sealer •Head Dia: 18mm •Stem Len: 20mm •Grey Nylon •Lexus 2000 - On •O/E# 75492-6030	20661 •Head: 16mm x 20mm •Stem Length: 9mm •Lexus 1997 - On •Moulding Clips •Nylon

SOURCE AUTO BODY FASTENERS					
SCREW GROMMETS 240 PCS KIT# 2055					
13930 Nissan & Mazda Screw Size: #8 Nylon Nut W. Nylon	9829 GM Headlight, Door #8 or #8 Screw Nylon Nut	9862 Ford Headlight, Door, & Grille #8 or #8 Screw Nylon Nut	9377 Chrysler Use with #8 Screw Nylon Nut	10330 Screw Size: #8 Nylon Nut	11691 Headlight Bolt GM Use W/ Nut Screw Nylon Nut
13960 GM Headlight, Door #8 Screw Nylon Nut Nylon	14274 Honda, Mazda, & Toyota Use with #10 Screw Nylon Nut	13932 Toyota Screw Size: 8mm Screw Grommets Nut, Nylon	14287 Honda Use #14 Screw Nylon Nut	14258 Screw Size: #10 Toyota Nylon Nut	11841 Screw Size: #8 Ford 1978 - On Grille Attachment Screw Grommets Nylon

Peter: 516-455-6331

Mike: 917-435-2648





Fax: 631- 648-9575







Email: XYZFastenersinc@gmail.com



www.xyzfasteners.com

ASSORTMENT

SOURCE AUTO BODY FASTENERS					
NISSAN RETAINERS 89 PCS #0007					
					
17347	16858	19274	19246	20953	17237
Nissan Head Diameter: 20mm Fits 7mm Hole Bumper Cover Retainers Nylon	Nissan Head Diameter: 20mm Stem Length: 18mm Fits In 8mm Hole Shield Retainers Nylon	Head Diameter: 20mm Fits Into 8mm Hole Nissan Front Fender Push-Type Retainers Nylon	Head Diameter: 18mm; Stem Length: 15mm Fits 10mm Hole Nissan 1994-On Push-Type Retainers Nylon	Front Bumper and Radiator Support Push-Type Retainer Head Dia: 20mm Stem Length: 15mm Fits Into 8mm Hole Nissan Altima, Maxima & Quest 2002-On Nissan 11296-AG000	Nissan 1981-On Outer Diameter: 20mm Stem Length: 9mm Head Insulation Retainers Nylon

SOURCE AUTO BODY FASTENERS					
TOYOTA PUSH TYPE RETAINERS 96 PCS #0005					
					
14260	20869	18888	17206	18939	18873
TOYOTA Fits 7mm Hole Push-Type Retainers nylon	Front Fender Liner Push-Type Retainer Head Dia: 18MM Stem Len: 7.5MM Fits Hole: 7MM Toyota Celica, Corolla, Matrix & 1999-On	Head Diameter: 20mm Fits Into 7mm Hole Toyota 1994-On Front Fender Liner Push-Type Retainers Nylon	Toyota Camry 1992-On Head Diameter: 18mm Stem Length: 20mm Fits Into Hole Bumper Cover Push-Type Retainers Nylon	LEXUS Head Diameter: 18mm Stem Length: 20mm Fits Into Hole Push-Type Retainers BLK NYLON	Head Diameter: 18mm Stem Length: 20mm Fits Into Hole Toyota Push-Type Retainers Blk Nylon

SOURCE AUTO BODY FASTENERS					
SMALL PUSH IN CLIPS 280 PCS #0020					
					
14921	14021	11680	19149	18302	15367
GM 25/64 Head Diameter 12mm Stem Length Door Weatherstrip Retainers Nylon	Ford Head Diameter: 7/16" Stem Length: 1/2" Xmas Tree Retainers Nylon	GM 1977-On Head Diameter: 7/16" Stem Length: 5/8" Stem Diameter: 3/16" Dash Panel Retainers Nylon	Head Diameter: 3/8" Stem Diameter: 7/32" Stem Length: 5/8" Chrysler Weatherstrip Retainers Nylon	GM 1989-On Head Diameter: 7/16" Stem Diameter: 7/32" Weatherstrip Retainers Blk Nylon	GM Head Diameter: 19/32" Stem Length: 3/4" Shroud Retainers Nylon

SOURCE AUTO BODY FASTENERS					
PLASTIC PUSH IN CLIPS 96 PCS #0019					
					
15414	16818	18301	20192	12137	15478
Chryls, GM & Ford Head Diameter: 11/16" Stem Length: 13/16" Stem Diameter: 5/16" In Shield Retainers Black Nylon	Head Diameter: 3/4" Stem Length: 7/8" Fits In 5/16 Hole Trim Panel Retainers Nylon	Head Diameter: 3/4" Stem Diameter: 11/32" Stem Length: 1-3/16" Gen 1995-On Bumper Fascia Retainers Black Nylon	Head Diameter: 11/16" Stem Diameter: 5/16" Stem Length: 1-3/4" Fascia Retainers Mod Flap Retainers	GM Head Diameter: 1" Stem Diameter: 7/16" Stem Length: 1 1/4" Panel Retainers Nylon	Head Diameter: 20mm Stem Length: 20mm Fascia Retainers Panel Retainers Nylon

Peter: 516-455-6331

Mike: 917-435-2648







Fax: 631- 648-9575

Email: XYZFastenersinc@gmail.com







www.xyzfasteners.com

ASSORTMENT

SOURCE AUTO BODY FASTNERS					
RETAINERS 6 STYLES 102 PCS					
					
17222 8MMHOLE G/M SATURN RETAINERS	17216 (6503598) GM SATURN PUSH TYPE RETAINERS	19233 ACURA 3.5RL 1996-ON PUSH TYPE RETAINERS	18873 TOYOTA PUSH TYPE RETAINERS	20564 ACURA & HONDA 1996-ON PUSH TYPE RETAINERS	19246 Nissan 1994-On PUSH TYPE RETAINERS (01553-09241)

SOURCE AUTO BODY FASTNERS					
HONDA BUMPER CLIPS 89 PCS # 3207A					
					
17143 Head Diameter: 20mm Stem Length: 27mm Fits 10mm Hole/ Heads 1990 - On Push-Type Retainers Black Nylon	18119 Honda 1990 - On Head Diameter: 20mm Fits In 10mm Hole Push-Type Bumper Retainers	19246 Head Diameter: 18mm; Stem Length: 15mm Fits 10mm Hole Nissan 1994-On Push-Type Retainers	19233 Head Diameter: 20mm Fits 10mm Hole Acura 3.5CL 1994-On Push-Type Retainers	21173 Bumper & Splash Shield Push-Type Retainer With Metal Insert Head Diameter: 20mm Stem Length: 16mm Fits Into 10mm Hole Acura MDX, RDX & TSX and Honda Accord, Civic, CR-V & Fit 2004 - 09 Head: 91506-59A,003 Black Nylon	20564 Head Diameter: 20mm Fits In 10mm Hole Acura & Honda 1996- On Push-Type Retainers Nylon

SOURCE AUTO BODY FASTNERS					
DOMESTIC RETAINERS 90 PCS # 30001					
					
12757 GM PUSH TYPE RETAINERS	13994 GM PRODUCT F CAR SPARE TIRE RETAINERS	17222 8MMHOLE G/M SATURN RETAINERS	19639 (15149708) FENDER RETAINERS	14753 GM 1986-ON RADIATOR SHROUD RETAINERS	14007 GM/ FENDER LINER PUSH TYPE RETAINERS

SOURCE AUTO BODY FASTNERS					
FORD FOREIGN DOOR PANEL CLIPS 105 PCS #0009					
					
11797 Ford 77-On Head Diameter: 3/4" Stem Length: 9/16" Fits 9/32 Hole Trim Panel Retainers Nylon	12565 Head Diameter: 25/32" Stem Diameter: 5/16" Stem Length: 5/8" Door Trim Panel Retainers Black Nylon	17124 Ford 1985 - On Sm. Head Diameter: 1 1/2" Stem Length: 3/4" Stem Diameter: 11/32" Trim Panel Retainers Nylon	17075 Ford Sm. Head Diameter: 1 1/2" Lg. Head Diameter: 3/4" Trim Panel Retainers Nylon	20253 Top Head Diameter: 1 1/2mm Stem Diameter: 9mm Stem Length: 15mm; Base 1987 - On Trim Panel Retainers Nylon	11349 AMC Head Diameter: 3/4" Stem Length: 11/16" Fits In 5/16 Hole Door Panel Retainers Nylon

Peter: 516-455-6331







Mike: 917-435-2648







Fax: 631- 648-9575







Email: XYZFastenersinc@gmail.com







www.xyzfasteners.com

ASSORTMENT







SOURCE AUTO BODY FASTNERS					
CHRYSLER - XMAS TREE RETAINERS 113 PICES #6803					
					
10831 GM, Ford, Chrysler Head Diameter: 11/16 Stem Length: 5/8 Stem Diameter: 5/16 Fender Shield Retainers Black-Nylon	11136 Ford & Chrysler Hood Insulation Radiator Grille Retainers Nylon	11146 1MM HOLE GM SATURN RETAINERS	11351 Ford, VW, Chrysler Head Diameter: 15/16 Stem Length: 11/16 Stem Diameter: 5/16 Door Trim Panel Retainers Black-Nylon	11678 Head Diameter: 15/16 Stem Diameter: 5/16 Stem Length: 11/16 Trim Panel Retainers W. Nylon	17004 Chrysler Head Insulation Retainers







SOURCE AUTO BODY FASTNERS					
FOREING RETAINERS 6 STYLES 90 PCS # 001					
					
19239 ACURA & HONDA FRONT FENDER PUSH - RETAINER	17216 (6503598) GM SATURN PUSH TYPE RETAINERS	19233 ACURA 3.5RL 1996-0N PUSH TYPE RETAINERS	18873 TOYOTA PUSH TYPE RETAINERS	20564 ACURA & HONDA 1996-0N PUSH TYPE RETAINERS	19246 Nissan 1994-On PUSH TYPE RETAINERS (01553-09241)







SOURCE AUTO BODY FASTNERS					
HONDA RETAINERS 106 PCS #0002					
					
16000 Honda, Mazda, & Nissan Fit In Sun Hole Head Diameter: 20mm Push-Type Retainers	16858 Head Diameter: 20mm Stem Length: 18mm Fit In 8/16in Hole Shield Retainers Nylon	19239 Head Diameter: 20mm Fit In Sun Hole Acura & Honda Front Fender Push- Type Retainers	17379 Head Accord 1998-On Head Diameter: 20mm Fit In 8/16in Hole Splash Shield Retainers Nylon	17057 Accord 1999-On Head Diameter: 18mm Stem Length: 21mm Fit In 8/16in Hole Push-Type Retainers Nylon	17216 Head Diameter: 20mm Fit Into Sun Hole Push-Type Retainers Nylon

SOURCE AUTO BODY FASTNERS					
GM DOOR PANEL CLIPS 105 PCS #0008					
					
11796 GM Head Diameter: 7/8" Stem Length: 3/4" Stem Diameter: 5/16in Door Trim Panel Retainers	15461 GMC 1977-On Trim Panel Retainers Nylon	18353 GM Trucks Head Diameter: 9/16" Fit Into 1/4 Hole Trim Panel Push-Type Retainers	12992 GM Stem Diameter: 5/16" Stem Length: 3/4" Trim Panel Retainers White Nylon	15669 GM Head Diameter: 15/16" Length: 1-1/4" 1987-On Trim Panel Retainers	16695 GM 1990-On Trim Panel Retainers

ASSORTMENT

SOURCE AUTO BODY FASTNERS					
BODY SHIMS 135 PCS #0017					
					
3155	3156	20323	20049	20048	8610
Thickness: 1/16" Size: 3/8" 1-1/4 x 1-1/8 Shims Zinc	1-1/4" x 1-1/8" Thickness: 1/8" Size: 3/8" Shims Zinc	1-3/8 x 1-1/4" w/ 5/8" Size Thickness: 3/16" Shims Zinc	Thickness: 1/8" Outer Diameter: 15/16" Size: 3/8" Shims Zinc	Thickness: 1/16" Outer Diameter: 15/16" Size: 3/8" Shims Zinc	Bolt Size: 1/2" Inner Diameter: 9/16" Outer Diameter: 1-2/8" 7/64" Thick Wrought Washers Zinc

SOURCE AUTO BODY FASTNERS					
THICK WROUGHT WASHERS ZINK 145 PCS KIT# 2054					
					
3988	3989	3990	8606	8608	8609
Bolt Size: 3/8" Inner Diameter: 13/32" Outer Diameter: 13/16" 1/16" Thick S.A.E. Washers Zinc	Bolt Size: 7/16" Inner Diameter: 15/32" Outer Diameter: 13/16" 1/16" Thick S.A.E. Washers Zinc	Bolt Size: 1/2" Inner Diameter: 17/32" Outer Diameter: 1-3/4" 1/16" Thick S.A.E. Washers Zinc	Bolt Size: 1/4" Inner Diameter: 5/16" Outer Diameter: 3/4" 1/16" Thick Wrought Washers Zinc	Bolt Size: 3/8" Inner Diameter: 7/16" Outer Diameter: 1" 5/64" Thick Wrought Washers Zinc	Bolt Size: 7/16" Inner Diameter: 1/2" Outer Diameter: 1-1/4" 5/64" Thick Wrought Washers Zinc

SOURCE AUTO BODY FASTNERS					
FOLD CLIPS 130 PCS #0014S					
					
9880	9879	10066	15752	16007	10064
#8 Screw Pul. Req: .025-.15 Hls. Center To Edge: 5/8" Edge: 3/8" Spring Type U Nuts	#8 Screw Range: .025-.150 Hls. Center to Edge: 5/8" Spring Type U Nuts	Screw Size: #10 Range: .025-.125 Center Hole to Edge: 13/32" U Type Nuts	Screw Size: #10 Range: .025-.150 Center Hole To Edge: 9/16" U Type Nuts Phosphate	Screw Size: #14 Range: .025-.125 Center Hole To Edge: 3/8" U Type Nuts	#6 Screw Range: .025-.125 Center Hole To Edge: 3/8" U Type Nuts

SOURCE AUTO BODY FASTNERS					
SELF DRILLING SCREWS BLACK 240 PCS Kit # 3216					
					
1208	1211	1202	1203	1207	1228
#10 x 3/4" Hex: 5/16" Hex Washer Head Teks Tapping Screws Black Oxide	#8 x 1/2" Outer Diameter: 7/16" GAL Phillips Washer Hd Teks Tapping Screws Zinc	#8 x 3/4" Phillips Round Washer Head Teks Tapping Screws Phosphate	M4.2 - L41 x 25mm (#8 x 1 1/2" 11mm) C/16.5 Washer Hd Round Washer Head Teks Tapping Screws Phosphate	#10 x 1/2" Hex: 5/16" Hex Washer Head Teks Tapping Screws Black Oxide	M4.2-L41 x 20mm Washer Outer Diameter: 17mm Hex: 5mm Tapping Screws Phosphate

Peter: 516-455-6331







Email: XYZFastenersinc@gmail.com









Mike: 917-435-2648













Fax: 631- 648-9575













www.xyzfasteners.com

ASSORTMENT

SOURCE AUTO BODY FASTNERS					
HONDA HOOD & WEATHERSTRIP 200 PCS #0003					
					
18818 •Head Size: 7mm x 15mm •Stem Length: 12mm •Fits Into 54mm Hole •Honda Hood Seal Retainers	18877 • Head Size: 5mm x 15mm •Honda •Weatherstrip Retainers	18033 •Chrysler •Hd Size: 1 1/4 x 2 1/32" •Stem Length: 15/32" •Stem Diameter: 1/4" •Weatherstrip Retainers •Nylon	18114 •Honda & Acura •Head Diameter: 13mm •Stem Length: 9mm •Acura & Honda •Hood Insulation Retaining Clips •Nylon	19114 •Head Diameter: 12mm •Stem Length: 9mm •Acura & Honda •Hood Insulation Retainers •Black Nylon	18746 •Head Diameter: 30mm •Stem Diameter: 10mm •Stem Length: 6mm •Acura 1991 - On Hood Insulation Retainers •Black Nylon

SOURCE AUTO BODY FASTNERS					
PUSH RETAINERS 150 PCS #2000					
					
201 Head Diameter: 2 1/2" Stem Diameter: 11.31" Stem Length: 3.31" On 1991 - On Bumper Facia Retainers	202 Head Diameter: 3/4" Stem Length: 7/8" Fits In 5/16 Hole Trim Panel Retainers Nylon	203 Stem Length: 1-1/16" GM 1994 - On Wing Harness & Headliner Retainers Nylon	204 Chev, GM & Ford Head Diameter: 11/16" Stem Length: 3/16" Diameter: 5/16" In Mold Retainers Black Nylon	205 Head Diameter: 11/16" Stem Length: 1/16" Stem Diameter: 5/16" Shield Retainers Nylon	206 •Head Diameter: 3/4" •Head Diameter: 11/32" •Stem Length: 13/16" •Chrysler Trim Panel Retainers Nylon
					
207 Diameter: 13/32" Stem Diameter: 5/16" Stem Length: 1-3/8" Ford 1997-Chevy Mold Tray Retainers	208 Ford Explorer Head Diameter: 5/8" Stem Length: 3/4" Stem Diameter: 3/8" Trim Panel Retainers	209 GM Head Diameter: 1" Stem Diameter: 7/8" Stem Length: 12/16" Stem Diameter: 11mm Facia Retainers Nylon	210 Head Diameter: 25mm Stem Length: 25mm Stem Diameter: 7.5mm Facia Retainers Nylon	211 Chrysler 1985 - On Head Diameter: 25mm Stem Length: 25mm Stem Diameter: 7.5mm Facia Retainers Nylon	212 Head Diameter: 1" Stem Diameter: 19/64" Stem Length: 1-1/8" Dodge/Chrysler 1995

SOURCE AUTO BODY FASTNERS					
ROCKER PANEL MOULDING CLIPS 96 PCS KIT#20572					
					
19820 999 - On Rocker Panel Moulding Clips	19822 GM 1995 - On	21321 Hyundai 2008 - On Hyundai: 47758-2L000 Blue Nylon	20328 •Chrysler •2004 - On	20481 •Pacifier Amtrak •GMC & K Trucks •2001 - On •Moulding Clips •Nylon	20607 •Top Head Size: 12mm x 20mm •Stem •2004 On
					
21064 Hyundai, Acura, Santa Fe & Tiburon 1998 - On Yellow	20756 Moulding Clip With Sealer Top Head Size: 18mm x 12mm Bottom Head Size: 18mm x 12mm Stem Length: 10mm	21136 Moulding Clip With Sealer Top Head Size: 18mm x 12mm Bottom Head Size: 18mm x 12mm Stem Length: 10mm	20774 Moulding Clip - GM	20377 GM Avalanche 2002 - On Moulding Clips Nylon	20568 Hyundai 2002 - On Rocker Panel Clips Nylon

SOURCE AUTO BODY FASTNERS					
ROCKER PANEL MOULDING CLIPS 96 PCS KIT#20571					
					
19820 999 - On Rocker Panel Moulding Clips	19822 GM 1995 - On	21321 Hyundai 2008 - On Hyundai: 47758-2L000 Blue Nylon	20885 Top Head Size: 12 x 20mm Bottom Head Size: 14 x 20mm Stem Len: 15MM Fits 5/16" Hole Grey Nylon	21374 Chevrolet Traverse 2010 - On GM: 115711175 Grey Nylon	20607 Top Head Size: 12mm x 20mm Facia 2004 On
					
21064 Hyundai, Acura, Santa Fe & Tiburon 1998 - On Yellow	20756 GM Moulding Clip	21136 Moulding Clip With Sealer Top Head Size: 18mm x 12mm Bottom Head Size: 18mm x 12mm Stem Length: 10mm	20328 •Chevrolet •2000 - On	20377 GM Avalanche 2002 - On Moulding Clips Nylon	20568 Hyundai 2002 - On Rocker Panel Clips Nylon

Peter: 516-455-6331







Mike: 917-435-2648







Fax: 631- 648-9575

Email: XYZFastenersinc@gmail.com







www.xyzfasteners.com

ASSORTMENT

SOURCE AUTO BODY FASTENERS					
NYLON BLACK RIVETS 120 PCS kit # 3012A					
					
13748 GM & VW Diameter: 13/64" Grip: 1/8 - 15/64	13750 GM, Ford & Chry. Diameter: 1/4" Grip: 5/32 - 13/32	13751 GM & Ford Diameter: 1/4" Grip: 5/32 13/32	13752 GM Diameter: 17/64" Grip: 3/64 - 5/32	13753 GM & VW Diameter: 17/64" Grip: 3/32 -3/16	13755 Chrysler Diameter: 13/64" Grip: 15/64- 25/64

SOURCE AUTO BODY FASTENERS					
Alum. Rivet & Mandrel Specialty Rivets #0415					
					
17639 Diameter: 1/4" Grip: 3/16 - 3/8 Bl. Alum. Rivet & Mandrel Specialty Rivets	18461 Diameter: 5/32" Grip: 3/64-1/4" All Black Aluminum Lincoln 1994 - On Specialty Rivets	19516 DIA: 1/4" GRIP: 3/64" - 1/4" FORD 96-ON SPLIT-TYPE RIVETS	17121 Diameter: 3/16" 5/16" - 15/64" Grip Split-Type Rivets	20971 GM APV Vans Diameter: 3/16" Moulding Attach. Aluminum Rivets Black	20629 CHRYSLER 1999-ON RIVETS

ASSORTMENT







SOURCE AUTO BODY FASTNERS					
ALL ALUMINUM AND MANDREL RIVETS 130 PCS kit # R2053					
 8312 -Diameter: 3/16" -Grip: Up to 3/8" -Large Flange Head: All	 8931 -Diameter: 1/8" -Grip: Up To 1/4 -All Aluminum -Blind Rivets	 11621 -Ford, GM, Chrysler -Diameter: 1/4" -Grip: 33/64-19/32 -Window Regulator Pool Type Rivets	 16834 -Diameter: 1/8" -Grip: 1/8-3/16 -Ford Windshield -Side Rail Aluminum Rivets	 16864 -GM -APV Vans -Diameter: 3/16" -Moulding Attach. Aluminum Rivets -Black	 17121 -Diameter: 3/16" -5/16" - 15/64" Grip -Split-Type Rivets

AMERICAN AUTO BODY SUPPLIES					
WHEATHERSTRIP RETAINERS 12 VARIETIES -245 PCS KIT# 6865					
 10744 GM Weatherstrip Retainers Nylon	 11120 GM 1967 - On Weatherstrip Retainers Nylon	 20344 Head Diameter: 7/16" Stem Diameter: 7/32"; Stem Length: 5/16" Gm 1995 - On	 11612 GM, Ford, & AMC 7/16 Head Diameter 5/8 Stem Length Weatherstrip Retainers Nylon	 14328 Honda Width: 7mm Length: 16mm Weatherstrip Clips Nylon	 14921 GM 25/64 Head Diameter 12mm Stem Length Door Weatherstrip Retainers Nylon
 17339 Lincoln 1989 - On Head Size: 5mm x 15mm Stem Length: 12Mm Weatherstrip Retainers Nylon	 18033 Chrysler Hd Sz: 1/4 x 21/32" Stem Length: 15/32" Stem Diameter: 1/4" Weatherstrip Retainers Nylon	 18297 Toyota Head Diameter: 13mm Fits: 5mm Hole Retaining Clips Nylon	 18877 Head Size: 5mm x 15mm Honda 1992-On Weatherstrip Retainers	 19171 Hd Size: 5mm x 15mm Stem Diameter: 5mm; Stem Length: 10mm Honda 1985 - On Weatherstrip Retainers Nylon	 19114 Hd Size: 6mm x 16mm Fits In 6mm Hole Honda Odyssey 1999 - On Cowl Vent Retaining Clips Black Nylon

XYZ FASTENERS

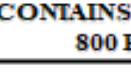
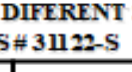
NEW KIT ASSORTMENTS

SOURCE AUTO BODY FASTENERS					
ALL ALUMINUM AND MANDREL RIVETS 180 PCS #1139					
<p>8903</p> <p>Flange Diameter : 3/8" Rivet Diameter : 3/16" Grip Range : 1/2-5/8" Rivet Length : 13/16" Material : Steel Rivet-Steel Mandrel Color : Silver</p> 	<p>8936</p> <p>Diameter: 3/16" Grip: Up to 3/8" Dome Head; All Aluminum Blind Rivets</p> 	<p>11620</p> <p>Ford, Chrysler, GM Diameter: 1/4" Grip: 1/32 - 9/64 Window Regulator Peel Type Rivets</p> 	<p>11621</p> <p>Ford, GM, Chrysler Diameter: 1/4" Grip: 33/64-19/32 Window Regulator Peel Type Rivets</p> 	<p>12652</p> <p>Ford 1981 - On Diameter 1/4" Grip: 1/8 - 1/4 Steel Mandrel Rivets</p> 	<p>14127</p> <p>Diameter: 3/16" Grip: 3/8 - 1/2 All Aluminum Ford Specialty Rivets</p> 
<p>18304</p> <p>Rivet Diameter : 1/8" Grip Range : 1/16-1/8" Flange Diameter : 3/8" Material : Black Aluminum Rivet-Steel Mandrel</p> 	<p>16864</p> <p>GM APV Vans Diameter: 3/16" Moulding Attach. Aluminum Rivets Black</p> 	<p>17121</p> <p>Diameter: 3/16" 5/16" - 15/64" Grip Split-Type Rivets</p> 	<p>17639</p> <p>Diameter: 1/4" Grip: 3/16 - 3/8 BL Alum. Rivet & Mandrel Specialty Rivets</p> 	<p>20629</p> <p>Material : Black Aluminum Rivet-Aluminum Mandrel</p> 	<p>18461</p> <p>Diameter: 5/32" Grip: 3/64-1/4" All Black Aluminum Lincoln 1994 - On Specialty Rivets</p> 

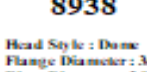
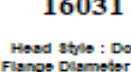
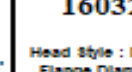
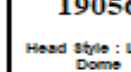
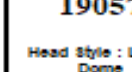
SOURCE AUTO BODY FASTENERS					
ALLUMINIUM RIVETS					
CONTAINS 12 DIFERENT SIZES					
800 PCS #31122-S					
<p>5754</p> <p>Head Style : Dome Flange Diameter : 3/8" Rivet Diameter : 3/16" Grip Range : 1/16-1/8" Rivet Length : 9/32" Material : Aluminum Rivet-Aluminum Mandrel Color : Silver</p> 	<p>8301</p> <p>Head Style : Dome Flange Diameter : 3/8" Rivet Diameter : 3/16" Grip Range : 1/4-3/8" Rivet Length : 9/16" Material : Aluminum Rivet-Aluminum Mandrel Color : Silver</p> 	<p>8311</p> <p>Head Style : Dome Flange Diameter : 3/8" Rivet Diameter : 3/16" Grip Range : 1/8-1/4" Rivet Length : 7/16" Material : Aluminum Rivet-Aluminum Mandrel Color : Silver</p> 	<p>8925</p> <p>Head Style : Dome Flange Diameter : 1/4" Rivet Diameter : 1/8" Grip Range : 3/16-1/4" Rivet Length : 3/8" Material : Aluminum Rivet-Aluminum Mandrel Color : Silver</p> 	<p>8931</p> <p>Head Style : Large Dome Flange Diameter : 3/8" Rivet Diameter : 1/8" Grip Range : 3/16-1/4" Rivet Length : 3/8" Material : Aluminum Rivet-Aluminum Mandrel Color : Silver</p> 	<p>8934</p> <p>Head Style : Dome Flange Diameter : 3/8" Rivet Diameter : 3/16" Grip Range : 1/16-1/8" Rivet Length : 9/32" Material : Aluminum Rivet-Aluminum Mandrel Color : Silver</p> 
<p>8937</p> <p>Head Style : Large Dome Flange Diameter : 5/8" Rivet Diameter : 3/16" Grip Range : 1/4-3/8" Rivet Length : 9/16" Material : Aluminum Rivet-Aluminum Mandrel Color : Silver</p> 	<p>8938</p> <p>Head Style : Dome Flange Diameter : 3/8" Rivet Diameter : 3/16" Grip Range : 3/8-1/2" Rivet Length : 11/16" Material : Aluminum Rivet-Aluminum Mandrel Color : Silver</p> 	<p>16031</p> <p>Head Style : Dome Flange Diameter : 1/4" Rivet Diameter : 1/8" Grip Range : 5/16-3/8" Rivet Length : 1/2" Material : Aluminum Rivet-Aluminum Mandrel Color : Silver</p> 	<p>16032</p> <p>Head Style : Dome Flange Diameter : 1/4" Rivet Diameter : 1/8" Grip Range : 3/8-1/2" Rivet Length : 5/8" Material : Aluminum Rivet-Aluminum Mandrel Color : Silver</p> 	<p>19056</p> <p>Head Style : Large Dome Flange Diameter : 5/8" Rivet Diameter : 3/16" Grip Range : 3/8-1/2" Rivet Length : 11/16" Material : Aluminum Rivet-Aluminum Mandrel Color : Silver</p> 	<p>19057</p> <p>Head Style : Large Dome Flange Diameter : 5/8" Rivet Diameter : 3/16" Grip Range : 1/2-5/8" Rivet Length : 13/16" Material : Aluminum Rivet-Aluminum Mandrel Color : Silver</p> 

Peter: 516-455-6331













Mike: 917-435-2648













Fax: 631-648-9575

Email: XYZFastenersinc@gmail.com













www.xyzfasteners.com













LIGHT BULBS







XYZ FASTENERS /SOURCE AUTO BODY					
PLUG-IN BULB 120 PCS #120SS					
1156 CLEAR	1157 CLEAR	194 CLEAR	2057 CLEAR	3156 CLEAR	7443 CLEAR
					
1156 AMBER	1157 AMBER	194 AMBER	2057 AMBER	3156 AMBER	7443 AMBER
					

XYZ FASTENERS /SOURCE AUTO BODY					
BULB CLEAR & AMBER 60 PCS Kit#BULB01					
7440 CLEAR	7443 CLEAR	194 CLEAR	916 CLEAR	906 CLEAR	921 CLEAR
					
7440 AMBER	7443 AMBER	194 AMBER	916 AMBER	906 AMBER	921 CLEAR
					

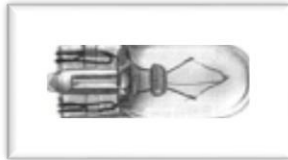
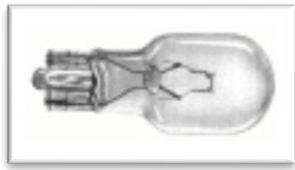
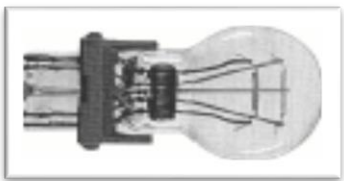
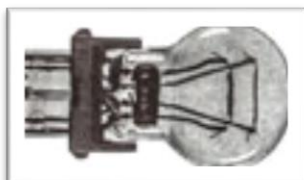
HALOGEN BULB 24 PCS KIT# H-235					
9004	9005	9006	9007	899	H-1
					
H-3	H-4	H-7	H-8	H-11	889
					

HALOGEN BULB 24 PCS KIT#H-236					
9004	9005	9006	9007	9008	H-1
					
H-3	H-4	H-7	H-8	H-11	889
					

BULBS		
<p>9004 BULB</p>  <p>2263 A 2 PCS</p>	<p>9005 BULB</p>  <p>2264 A 2 PCS</p>	<p>9006BULB</p>  <p>2265 A 2 PCS</p>
<p>9007 BULB</p>  <p>2266A 2 PCS</p>	<p>9008= H-13 BULB</p>  <p>2267 A 2 PCS</p>	<p>17881 BULB</p>  <p>2268 A 10 PCS</p>
<p>H-8 HALON BULB</p>  <p>2269A 2 PCS</p>	<p>H-9 HALON BULB</p>  <p>2270 A 2 PCS</p>	<p>H-10 HALON BULB</p>  <p>2271 A 2 PCS</p>
<p>H-11 HALON BULB</p>  <p>2272 A 2 PCS</p>	<p>880 BULB</p>  <p>2273 A 2 PCS</p>	<p>899 BULB</p>  <p>2274 A 2 PCS</p>

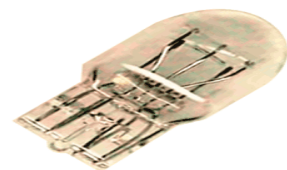
BULBS		
<p>24 Miniature Bulb</p> <div style="text-align: center;">  </div> <p style="text-align: center;">10 Box</p> <p style="text-align: center;">Clear/ Amber</p> <p>2201 A 10 PCS Clear 2202 A 10 PCS Amber</p>	<p>194 Miniature Bulbs</p> <div style="text-align: center;">  </div> <p style="text-align: center;">10 Box Clear/ Amber</p> <p>2203 A 10 PCS Clear 2204 A 10 PCS Amber 2282 A 10 PCS Blue</p>	<p>906 Miniature Bulbs</p> <div style="text-align: center;">  </div> <p style="text-align: center;">10 Box Clear/ Amber</p> <p>2205 A 10 PCS Clear 2206 A 10 PCS Amber</p>
<p>4157LL Bulb</p> <div style="text-align: center;">  </div> <p style="text-align: center;">10 Box Clear/ NAK</p> <p>2208 A 10 PCS Clear \$ 2209 A 10 PCS Amber \$</p>	<p>3457NA Bulb</p> <div style="text-align: center;">  </div> <p>2210 A 10 PCS Clear 2211 A 10 PCS Amber</p>	<p>1895 Bulb</p> <div style="text-align: center;">  </div> <p style="text-align: center;">10 Box Clear</p> <p>2214 A 10 PCS Clear</p>
<p>916 Bulb</p> <div style="text-align: center;">  </div> <p>2215 A 10 PCS Clear 2216 A 10 PCS Amber</p>	<p>H -1 Clear</p> <div style="text-align: center;">  </div> <p>2217 A 2 PCS Clear</p>	<p>4057k 10 Clear</p> <div style="text-align: center;">  </div> <p>2218 A 10 PCS</p>
<p>921 Bulb 10 Box Clear</p> <div style="text-align: center;">  </div> <p>2221 A 10 PCS Clear</p>	<p>7440 Clear /Amber</p> <div style="text-align: center;">  </div> <p>2224 A 10 PCS Clear 2225A 10 PCS Amber</p>	<p>7443 Clear / Amber</p> <div style="text-align: center;">  </div> <p>2226 A 10 PCS Clear 2227 A 10 PCS Amber</p>







Peter: 516-455-6331

Mike: 917-435-2648

Fax: 631- 648-9575

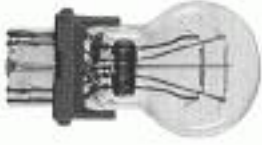
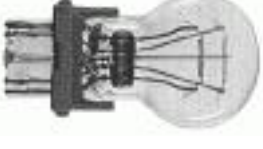
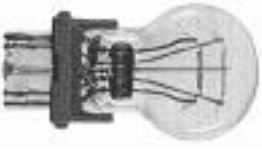
Email: XYZFastenersinc@gmail.com

www.xyzfasteners.com

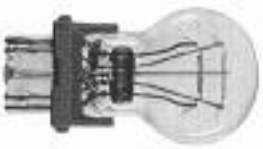
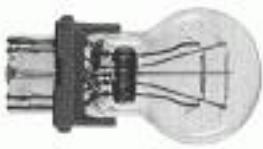
BULBS		
<p>1156 Clear /Amber</p>  <p>2228 10 PCS Clear 2229 10 PCS Amber</p>	<p>1157 Clear /Amber</p>  <p>2230 10 PCS Clear 2231 10 PCS Amber</p>	<p>2057 Clear /Amber</p>  <p>2232 10 PCS Clear 2233 10 PCS Amber</p>
<p>3156 Clear /Amber</p>  <p>2234 A 10 PCS Clear 2235 A 10 PCS Amber</p>	<p>3157 Clear /Amber</p>  <p>2236 A 10 PCS Clear 2237 A 10 PCS Amber</p>	<p>3357 Clear /Amber</p>  <p>2238 A 10 PCS Clear 2239 A 10 PCS Amber</p>
<p>H-7</p>  <p>2242 A 2 PCS</p>	<p>H-4 = 9003</p>  <p>2243 A 2 PCS</p>	<p>7444 BULB Clear /Amber</p>  <p>2275 A 10 PCS Clear 2276 A 10 PCS Amber</p>
<p>3057 Clear /Amber</p>  <p>2248 A 10 PCS Clear 2249 A 10 PCS Amber</p>	<p>3457 Clear /Amber</p>  <p>2250 A 10 PCS Clear 2251 A 10 PCS Amber</p>	<p>3757 Clear /Amber</p>  <p>2261 A 10 PCS Clear 2262A 10 PCS Amber</p>

ELECTRICAL CONNECTORS		
<p>#6 YELLOW RING</p>  <p>2710 A PCS 50 2710 B PCS 250 2710 C PCS 500</p>	<p>#8 YELLOW RING</p>  <p>2711 A PCS 50 2711 B PCS 250 2711 C PCS 500</p>	<p>#10 YELLOW RING</p>  <p>2712 A PCS 50 2712 B PCS 250 2712 C PCS 500</p>
<p>#1/4 YELLOW RING</p>  <p>2701 A PCS 50 2701 B PCS 250 2701 C PCS 500</p>	<p># 5/16 YELLOW RING</p>  <p>2702 A PCS 50 2702 B PCS 250 2702 C PCS 500</p>	<p>#3/8 YELLOW RING</p>  <p>2703 A PCS 50 2703 B PCS 250 2703 C PCS 500</p>
<p>#1/2 YELLOW RING</p>  <p>2704 A PCS 50 2704 B PCS 250 2704 C PCS 500</p>	<p>BLACK SHRINK TUBING-8"</p>  <p>2228 1/8" 2229 3/16" 2230 1/4 "</p>	<p>RED SPADE</p>  <p>2705 A PCS50 2705 B PCS 250 2705 C PCS500</p> <p>BLUE SPADE</p> <p>2705 A PCS 50 2705 B PCS 250 2705 C PCS 500</p>
<p>AWG SOLDER SEAL TYPE HEATH SHRINK TUBING BUTT SPLICES</p> <p><small>Butt Connector 14-16 AWG, Blue</small></p>  <p>RED 18-20 27077 C PCS 15 27077C PCS 250</p> <p>BLUE 14-16 27088 C PCS 15 27088 C PCS 250</p> <p>YELLOW10-12 27041 C PCS 15 27041C PCS 250</p>	<p>RED MALE</p> <p>2223 A PCS 50 2223 B PCS 250 2223 C PCS 500</p> <p>BLUE MALE</p> <p>2224 A PCS 50 2224 B PCS 250 2224 C PCS 500</p>  	<p>RED FEMALE</p> <p>2722 A PCS 50 2722 B PCS 250 2722 C PCS 500</p> <p>BLUE FEMALE</p> <p>2231 A PCS 50 2231 B PCS 250 2231 C PCS 500</p>  

Peter: 516-455-6331













Mike: 917-435-2648

Fax: 631- 648-9575

Email: XYZFastenersinc@gmail.com

www.xyzfasteners.com

XYZ FASTENERS

<p style="text-align: center;">#6 RED RING</p>  <p>2716 A PCS 50 2716 B PCS 250 2716 C PCS 500</p>	<p style="text-align: center;">#8 RED RING</p>  <p>2717 A PCS 50 2717 B PCS 250 2717 C PCS 500</p>	<p style="text-align: center;">#10 RED RING</p>  <p>2718 A PCS 50 2718 B PCS 250 2718 C PCS 500</p>
<p style="text-align: center;">#1/4 RED RING</p>  <p>2719 A PCS 50 2719 B PCS250 2719 C PCS 500</p>	<p style="text-align: center;">#5/16 RED RING</p>  <p>2719 A PCS 50 2719 B PCS250 2719 C PCS 500</p>	<p style="text-align: center;"># 3/8 RED RING</p>  <p>2721 A PCS 50 2721 B PCS250 2721 C PCS 500</p>
<p style="text-align: center;">#6 BLUE RING</p>  <p>2734 A PCS 50 2734 B PCS 250 2734 C PCS 500</p>	<p style="text-align: center;">#8 BLUE RING</p>  <p>2735 A PCS 50 2735 B PCS250 2736 C PCS 500</p>	<p style="text-align: center;">#10 BLUE RING</p>  <p>2736 A PCS 50 2736 B PCS250 2736 C PCS 500</p>
<p style="text-align: center;">#1/4 BLUE RING</p>  <p>2707 A PCS 50 2707 B PCS 250 2707 C PCS 500</p>	<p style="text-align: center;">#5/16 BLUE RING</p>  <p>2708 A PCS 50 2708 B PCS 250 2708 C PCS 500</p>	<p style="text-align: center;">#3/8 BLUE RING</p>  <p>2709 A PCS 50 2709 B PCS 250 2709 C PCS 500</p>

Peter: 516-455-6331

Mike: 917-435-2648

Fax: 631- 648-9575

Email: XYZFastenersinc@gmail.com

www.xyzfasteners.com

ELECTRICAL CONNECTORS

<p>BLUE MALE BULLET</p>  <p>2713 A PCS 50 2713 B PCS 250 2713 C PCS 500</p>	<p>BLUE FEMALE BULLET</p>  <p>2714 A PCS 50 2714 B PCS 250 2714 C PCS 500</p>	<p>3M BLUE SCOTHLOKS</p>  <p>2715 A PCS 50 2715 B PCS 250 2715 C PCS 500</p>
<p>RED BUTT SPLICE</p>  <p>2143 A PCS 100 2143 B PCS 250 2143 C PCS 500</p>	<p>RED BUTT SPLICE SEE THROUGH</p>  <p>2225 A PCS 100 2225 B PCS 250 2225 C PCS 500</p>	<p>HEAT SHRINK RED BUTT SPLICE</p>  <p>2740 A PCS 100 2740 B PCS 250 2740 C PCS 500</p>
<p>BLUE BUTT SPLICE</p>  <p>2744 A PCS 100 2744 B PCS250 2744 C PCS 500</p>	<p>BLUE BUTT SPLICE SEE THROUGH</p>  <p>2226 A PCS 100 2226 B PCS250 2226 C PCS 500</p>	<p>BLUE HEAT SHRINK BUTT SPLICE</p>  <p>2741 A PCS 100 2741 B PCS250 2741 C PCS 500</p>
<p>YELLOW BUTT SPLICE</p>  <p>2745 A PCS 50 2745 B PCS250 2745 C PCS 500</p>	<p>YELLOW BUTT SPLICE SEE THROUGH</p>  <p>2227 A PCS 50 2227 B PCS 250 2227 C PCS 500</p>	<p>YELLOW HEAT SHRINK BUTT SPLICE</p>  <p>2742 A PCS 15 2742 B PCS 250 2742 C PCS 500</p>

Peter: 516-455-6331

Mike: 917-435-2648

Fax: 631- 648-9575

Email: XYZFastenersinc@gmail.com

www.xyzfasteners.com

FUSES

ATM
 QTY :100/ box \$
 QTY : 20/ BOX \$
 2 Amp #26080
 3 Amp # 26081
 4 Amp #26082
 5 Amp #26083
 7.5 Amp #26084
 10 Amp #26085
 15 Amp #26089
 20 Amp #26090
 25 Amp #26091
 30 Amp #26092



ATX
 QTY :100/ box \$60.00
 QTY : 4/ BOX \$6.94
 20 Amp ATX #2614
 30 Amp ATX # 2615
 40 Amp ATX #2616
 50 Amp ATX #2617
 60 Amp ATX #2618
 70 Amp ATX #2619
 80 Amp ATX #2620
 100 Amp ATX2 #2621



ATO
 QTY :100/ box \$
 QTY : 20/ BOX \$
 2 Amp #2610
 3 Amp #2611
 4 Amp #2611
 5 Amp #2612
 7.5 Amp #2613
 10 Amp #2622
 15 Amp #2623
 20 Amp #2624
 25 Amp #2625
 30 Amp #2626
 30 Amp #2627
 40 Amp #2628



FEMALE PAL
 QTY : 2/ BOX
 FLF-20 #26010
 FLF-30 #26011
 FLF-40 #26013
 FLF-50 #26014
 FLF-60 #26015
 FLF-80 #26016
 FLF-100 #26012



MALE PAL
 QTY : 2/ BOX \$
 FLM-30 #26020
 FLM-40 #26021
 FLM-50 #26022
 FLM-60 #26023
 FLM-80 #26024
 FLM-100 #26025



FUSES

BENT LEG PAL

QTY : 2/ BOX \$

FLB-20 #26030

FLB-30 #26031

FLB-40 #26032

FLB-50 #26033

FLB-60 #26034

FLB-70 #26035

FLB-80 #26036

FLB-100 #26037

FLB-120 #2603



LOW PROFILE

QTY :100/ box \$

QTY : 10/ BOX \$

2 Amp #26040

3 Amp # 26041

4 Amp #26042

5 Amp #26043

7.5 Amp #26044

10 Amp #26045

15 Amp #26046

20 Amp #26047

25 Amp #26048

30 Amp #26049



JCAS

QTY : 10/ BOX \$

JCAS 20 #26060

JCAS 30#26061

JCAS 40#26062

JCAS 50#26063

JCAS 60#26064



FMX

QTY : 2/ BOX

FMX 20 #26070

FMX 30 #26071

FMX 40 #26072

FMX 50 #26073

FMX 60 #26074

FMX-70 #26075

FMX 80 #2607



MECHANICAL SUPPLIES

PRIMARY WIRE-100''



18 GAUGE

- BLACK #2904 \$
- RED #2905 \$

16 GAUGE

- YELLOW #2906 \$
- RED #2907 \$
- BLACK #2908 \$
- GREEN #2910 \$
- WHIT #2911 \$
- BLUE #2912 \$
- BROWN #2914 \$

14 GAUGE

- YELLOW #2908
- RED #2909
- BLACK #2910
- GREEN #2911
- BLUE #2914
- BROWN #2915



HEATER HOSE -5



- #29010 1/2
- #29011 5/8''
- #29012 3/4'



FUEL LINE HOSE -2

- # 29020 3/6''
- # 29021 1/4''
- # 29022 5/16''
- # 29023 3/8''
- # 29024 7/16''

“SANDING DISCS ROLLOCKS”

	<p>SAF2554 2” 24 GRIT 50 PCS SAF2556 2” 36 GRIT 50 PCS SAF2552 2” 50 GRIT 50 PCS</p> <hr/> <p>SAF2553 3” 24 GRIT 25 PCS SAF2551 3” 50 GRIT 25 PCS SAF2557 3” 36 GRIT 25 PCS</p>
<p>ROLLOCKS HARD</p>  <p>BACKING ZIRCONIUM</p>	<p>SAF2731 2” 24 GRIT 25 PCS SAF2732 2” 36 GRIT 25 PCS</p> <hr/> <p>SAF2777 3” 24 GRIT 25 PCS SAF2778 3” 36 GRIT 25 PCS SAF2739 3” 50 GRIT 25 PCS</p>
<p>ROLLOCKS HARD BACKING ALUM.OXIDE</p> 	<p>SAF4484 2” 24 GRIT 20 PCS SAF4485 2” 36 GRIT 20 PCS SAF4486 2” 50 GRIT 20 PCS</p> <hr/> <p>SAF4481 3” 24 GRIT 20 PCS SAF4482 3” 36 GRIT 20 PCS</p>

“SURFACE PREPS ROLLOCKS”



SAF2667 2” GREEN (fine) 40 PCS
SAF2665 2” MAROON (med) 40 PCS
SAF2515 2” BROWN (coarse) 40 PCS

SAF2668 3” GREEN (fine) 25 PCS
SAF2666 3” MAROON (med) 25 PCS
SAF2516 3” BROWN (coarse) 25 PCS

“CUT OF WHEELS”



SAF2900 1/16” THICK 25 PCS
SAF2910 1/32” THICK 50 PCS

SAF3153 3” 50 PCS
SAF4065 4” 25 PCS
SAF2513 3” 100 PCS
SAF2582 4” 100 PCS

SFA3155 1/4” THICK GRINING DISCS FOR SPOTS WELD GRINING

**FLAP DISCS
MINI DISCS ROLLOCKS**



Mini Discs-Rollocks (10/box)

- SAF2351 2" 40 Grit 10 PCS
- SAF2352 2" 60 Grit 10 PCS
- SAF2353 2" 80 Grit 10 PCS
- SAF2354 3" 40 Grit 10 PCS
- SAF2355 3" 60 Grit 10 PCS
- SAF2356 3" 80 Grit 10 PCS

FLAP DISCS ZIRCONIA

- Premium Zirconia grit delivers ultimate grinding performance
- Advanced bonding formulation provides cool grinding action, extending disc life.
- Available up to 120 grit

4 1/2" x 7/8" hole Zirconium (each)

SAF2517 40 Grit 1 PCS

SAF2524 60 Grit 1 PCS



Replacement belts (10/pkg.)

- SAF303736 36 Grit
- SAF303740 40 Grit
- SAF303760 60 Grit
- SAF303780 80 Grit

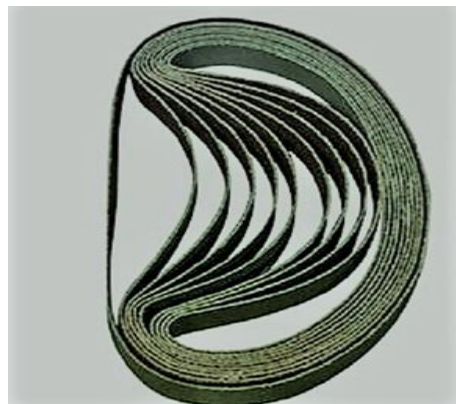

Peter: 516-455-6331

Mike: 917-435-2648

Fax: 631- 648-9575

Email: XYZFastenersinc@gmail.com

www.xyzfasteners.com

TRIM-KUTS DISCS



SAF2530 24 GRIT 20PCS
SAF2537 36 GRIT 20PCS

“Includes one arbor “



GEM SUPREME Latest innovative Resin Fibre Disc with advanced technology for superior grinding applications.

- GEM SUPREME: Unique blend of SGT Ceramic and Zirconia grain.
- This is an advanced Resin Fibre Disc for light to heavy pressure grinding requirements.
- Wide range of metals grinding and finishing applications including Aerospace Industry.
- Provides optimum value.

5" x 7/8" HOLE

SAF2708 24 GRIT 25 PCS

22040200

SAF2709 36 GRIT 25 PCS

22040300

ROLLOCK DISCS HOLDERS



SAF2712 2" HOLDER 1 PCS

70020003

SAF2713 3" HOLDER 1 PCS

70030001



Peter: 516-455-6331

Mike: 917-435-2648

Fax: 631- 648-9575

Email: XYZFastenersinc@gmail.com

www.xyzfasteners.com

<p style="text-align: center;">1/2"-13 Bolts</p> <p><u>Bolt Setup (1 bolt, nut & washer, GR8, Yellow Zinc)</u></p> <p>SAF3055 1/2" X 1 1/2" SAF3056 1/2" X 2" SAF3057 1/2" X 2 1/2" SAF3058 1/2" X 3" SAF3059 1/2" X 3 1/2" SAF3060 1/2" X 4"</p> <p><u>Grade 8, Yellow Zinc Bolts (Boxed)</u></p> <p>SAF4265 1/2" X 1" (25/box) SAF4267 1/2" X 1 1/2" (25/box) SAF4269 1/2" X 2" (10/box) SAF4271 1/2" X 2 1/2" (10/box) SAF4273 1/2" X 3" (10/box) SAF4275 1/2" X 3 1/2" (10/box) SAF4276 1/2" X 4" (10/box)</p>	<div style="text-align: center;">  </div> <p style="text-align: center;">9/16"-12 Bolts</p> <p><u>Bolt Setup (1 bolt, nut & washer, GR8, Yellow Zinc)</u></p> <p>SAF3065 9/16" X 3" SAF3066 9/16" X 3 1/2" SAF3062 9/16" X 4"</p> <p><u>Grade 8, Yellow Zinc Bolts (Boxed)</u></p> <p>SAF4287 9/16" X 3" (10/box) SAF4288 9/16" X 3 1/2" (10/box) SAF4290 9/16" X 4" (10/box)</p>
<p style="text-align: center;">5/8"-11 Bolts</p> <div style="text-align: center;">  </div> <p><u>Bolt Setup (1 bolt, nut & washer, GR8, Yellow Zinc)</u></p> <p>SAF3081 5/8" X 3" SAF3082 5/8" X 3 1/2" SAF3083 5/8" X 4" SAF3084 5/8" X 4 1/2" SAF3085 5/8" X 5" SAF3086 5/8" X 5 1/2"</p> <p><u>Grade 8, Yellow Zinc Bolts (Boxed)</u></p> <p>F4301 5/8" X 2" (10/box) SAF4302 5/8" X 2 1/2" (10/box) SAF4303 5/8" X 3" (10/box) SAF4304 5/8" X 3 1/2" (10/box) SAF4305 5/8" X 4" (5/box) SAF4306 5/8" X 4 1/2" (5/box) SAF4307 5/8" X 5" (5/box) SAF4308 5/8" X 5 1/2" (5/box)</p>	<p style="text-align: center;">3/4"-10 Bolts</p> <p><u>Bolt Setup (1 bolt, nut & washer, GR8, Yellow Zinc)</u></p> <p>SAF3087 3/4" X 3" SAF3089 3/4" X 3 1/2" SAF3090 3/4" X 4" SAF3091 3/4" X 4 1/2" SAF3092 3/4" X 5" SAF3093 3/4" X 5 1/2" SAF3094 3/4" X 6"</p> <p><u>Grade 8, Yellow Zinc Bolts (Boxed)</u></p> <p>SAF4314 3/4" X 3" (5/box) SAF4315 3/4" X 3 1/2" (5/box) SAF4316 3/4" X 4" (5/box) SAF4317 3/4" X 4 1/2" (4/box) SAF4318 3/4" X 5" (4/box) SAF4319 3/4" X 5 1/2" (4/box) SAF4320 3/4" X 6" (Qty:4)</p>
<p style="text-align: center;">Washers</p> <p>SAF2932 1/2" SAE (20/box) SAF2933 9/16" SAE (20/box) SAF2934 5/8" SAE (20/box) SAF2935 3/4" SAE (20/box)</p>	<p style="text-align: center;">Hex Nuts</p> <p>SAF2936 1/2" (25/box) SAF2937 9/16" (25/box) SAF2938 5/8" (25/box) SAF2939T 3/4" (25/box)</p>

AMERICAN THREAD HARDWARE

**SPLIT LOCK
WASHERS**



Size	PCS	#
1/4"	50	8061
5/16"	50	8062
3/8"	50	8063
7/16"	50	8064

WASHERS



Size	PCS	#
1/4"	100	8065
5/16"	100	8066
3/8"	50	8067
7/16"	50	8068
1/2"	20	8069
9/16"	20	8070
5/8"	20	8071
3/4"	20	8072

HEX NUTS



Size	PCS	#
1/4"	50	8073
5/16"	50	8074
3/8"	50	8075
7/16"	25	8076
1/2"	25	8077
9/16"	25	8078
5/8"	25	8079
3/4"	25	8080

AMERICAN THREAD HARDWARE



BOLTS – GR8 YELLOW ZINC

<p>1/4</p> <table border="1"> <thead> <tr> <th>Size</th> <th>PCS</th> <th>#</th> <th></th> </tr> </thead> <tbody> <tr><td>1/4 -20 x 1/2"</td><td>50</td><td>804</td><td></td></tr> <tr><td>1/4 -20 x 3/4"</td><td>50</td><td>805</td><td></td></tr> <tr><td>1/4 -20 x 1"</td><td>50</td><td>806</td><td></td></tr> <tr><td>1/4 -20 x 1-1/4"</td><td>50</td><td>807</td><td></td></tr> <tr><td>1/4 -20 x 1-1/2"</td><td>50</td><td>808</td><td></td></tr> <tr><td>1/4- 20 x 2"</td><td>50</td><td>809</td><td></td></tr> <tr><td>1/4 -20 x 2-1/4"</td><td>25</td><td>8010</td><td></td></tr> <tr><td>1/4- 20 x 2-1/2"</td><td>25</td><td>8011</td><td></td></tr> </tbody> </table>				Size	PCS	#		1/4 -20 x 1/2"	50	804		1/4 -20 x 3/4"	50	805		1/4 -20 x 1"	50	806		1/4 -20 x 1-1/4"	50	807		1/4 -20 x 1-1/2"	50	808		1/4- 20 x 2"	50	809		1/4 -20 x 2-1/4"	25	8010		1/4- 20 x 2-1/2"	25	8011		<p>7/16</p> <p>U.S.S. (Coarse) Threads Per Inch: 14 S.A.E. (Fine) Threads Per Inch: 20</p> <table border="1"> <thead> <tr> <th>Size</th> <th>PCS</th> <th>#</th> <th></th> </tr> </thead> <tbody> <tr><td>7/16 x 1"</td><td>25</td><td>8031</td><td></td></tr> <tr><td>7/16 x 1-1/4"</td><td>25</td><td>8032</td><td></td></tr> <tr><td>7/16 x 1-1/2"</td><td>25</td><td>8033</td><td></td></tr> <tr><td>7/16 x 2"</td><td>25</td><td>8034</td><td></td></tr> <tr><td>7/16 x 2-1/2"</td><td>25</td><td>8035</td><td></td></tr> <tr><td>7/16 x 3"</td><td>25</td><td>8036</td><td></td></tr> <tr><td>7/16 x 4"</td><td>25</td><td>8037</td><td></td></tr> <tr><td>7/16 x 5-1/2"</td><td>10</td><td>8038</td><td></td></tr> </tbody> </table>				Size	PCS	#		7/16 x 1"	25	8031		7/16 x 1-1/4"	25	8032		7/16 x 1-1/2"	25	8033		7/16 x 2"	25	8034		7/16 x 2-1/2"	25	8035		7/16 x 3"	25	8036		7/16 x 4"	25	8037		7/16 x 5-1/2"	10	8038													
Size	PCS	#																																																																																									
1/4 -20 x 1/2"	50	804																																																																																									
1/4 -20 x 3/4"	50	805																																																																																									
1/4 -20 x 1"	50	806																																																																																									
1/4 -20 x 1-1/4"	50	807																																																																																									
1/4 -20 x 1-1/2"	50	808																																																																																									
1/4- 20 x 2"	50	809																																																																																									
1/4 -20 x 2-1/4"	25	8010																																																																																									
1/4- 20 x 2-1/2"	25	8011																																																																																									
Size	PCS	#																																																																																									
7/16 x 1"	25	8031																																																																																									
7/16 x 1-1/4"	25	8032																																																																																									
7/16 x 1-1/2"	25	8033																																																																																									
7/16 x 2"	25	8034																																																																																									
7/16 x 2-1/2"	25	8035																																																																																									
7/16 x 3"	25	8036																																																																																									
7/16 x 4"	25	8037																																																																																									
7/16 x 5-1/2"	10	8038																																																																																									
<p>5/16 U.S.S. (Coarse) Threads Per Inch: 18 S.A.E. (Fine) Threads Per Inch: 24</p> <table border="1"> <thead> <tr> <th>Size</th> <th>PCS</th> <th>#</th> <th></th> </tr> </thead> <tbody> <tr><td>5/16-18 x 1/2"</td><td>50</td><td>8012</td><td></td></tr> <tr><td>5/16 -18 x 3/4"</td><td>50</td><td>8013</td><td></td></tr> <tr><td>5/16 -18 x 1"</td><td>25</td><td>8014</td><td></td></tr> <tr><td>5/16-18 x 1-1/4"</td><td>25</td><td>8015</td><td></td></tr> <tr><td>5/16-18 x 1-1/2"</td><td>25</td><td>8016</td><td></td></tr> <tr><td>5/16 -18 x 1-3/4"</td><td>25</td><td>8017</td><td></td></tr> <tr><td>5/16 -18 x 2"</td><td>25</td><td>8018</td><td></td></tr> <tr><td>5/16-18 x 2-1/2"</td><td>25</td><td>8019</td><td></td></tr> <tr><td>5/16-18 x 3"</td><td>25</td><td>8020</td><td></td></tr> </tbody> </table>				Size	PCS	#		5/16-18 x 1/2"	50	8012		5/16 -18 x 3/4"	50	8013		5/16 -18 x 1"	25	8014		5/16-18 x 1-1/4"	25	8015		5/16-18 x 1-1/2"	25	8016		5/16 -18 x 1-3/4"	25	8017		5/16 -18 x 2"	25	8018		5/16-18 x 2-1/2"	25	8019		5/16-18 x 3"	25	8020		<p>1/2" U.S.S. (Coarse) Threads Per Inch: 13 S.A.E. (Fine) Threads Per Inch: 20</p> <table border="1"> <thead> <tr> <th>Size</th> <th>PCS</th> <th>#</th> <th></th> </tr> </thead> <tbody> <tr><td>1/2 x 1"</td><td>25</td><td>8039</td><td></td></tr> <tr><td>1/2 x 1-1/4"</td><td>25</td><td>8040</td><td></td></tr> <tr><td>1/2 x 1-1/2"</td><td>25</td><td>8041</td><td></td></tr> <tr><td>1/2 x 1-3/4"</td><td>25</td><td>8042</td><td></td></tr> <tr><td>1/2 x 2"</td><td>25</td><td>8043</td><td></td></tr> <tr><td>1/2 x 2-1/2"</td><td>25</td><td>8044</td><td></td></tr> <tr><td>1/2 x 2-3/4"</td><td>10</td><td>8045</td><td></td></tr> <tr><td>1/2 x 3"</td><td>10</td><td>8046</td><td></td></tr> <tr><td>1/2 x 4"</td><td>10</td><td>8047</td><td></td></tr> <tr><td>1/2 x 5"</td><td>10</td><td>8048</td><td></td></tr> </tbody> </table>				Size	PCS	#		1/2 x 1"	25	8039		1/2 x 1-1/4"	25	8040		1/2 x 1-1/2"	25	8041		1/2 x 1-3/4"	25	8042		1/2 x 2"	25	8043		1/2 x 2-1/2"	25	8044		1/2 x 2-3/4"	10	8045		1/2 x 3"	10	8046		1/2 x 4"	10	8047		1/2 x 5"	10	8048	
Size	PCS	#																																																																																									
5/16-18 x 1/2"	50	8012																																																																																									
5/16 -18 x 3/4"	50	8013																																																																																									
5/16 -18 x 1"	25	8014																																																																																									
5/16-18 x 1-1/4"	25	8015																																																																																									
5/16-18 x 1-1/2"	25	8016																																																																																									
5/16 -18 x 1-3/4"	25	8017																																																																																									
5/16 -18 x 2"	25	8018																																																																																									
5/16-18 x 2-1/2"	25	8019																																																																																									
5/16-18 x 3"	25	8020																																																																																									
Size	PCS	#																																																																																									
1/2 x 1"	25	8039																																																																																									
1/2 x 1-1/4"	25	8040																																																																																									
1/2 x 1-1/2"	25	8041																																																																																									
1/2 x 1-3/4"	25	8042																																																																																									
1/2 x 2"	25	8043																																																																																									
1/2 x 2-1/2"	25	8044																																																																																									
1/2 x 2-3/4"	10	8045																																																																																									
1/2 x 3"	10	8046																																																																																									
1/2 x 4"	10	8047																																																																																									
1/2 x 5"	10	8048																																																																																									
<p>3/8</p> <p>U.S.S. (Coarse) Threads Per Inch: 16 S.A.E. (Fine) Threads Per Inch: 24</p> <table border="1"> <thead> <tr> <th>Size</th> <th>PCS</th> <th>#</th> <th>PRICE</th> </tr> </thead> <tbody> <tr><td>3/8 x 3/4"</td><td>25</td><td>8021</td><td></td></tr> <tr><td>3/8 x 1"</td><td>25</td><td>8022</td><td></td></tr> <tr><td>3/8 x 1-1/4"</td><td>25</td><td>8023</td><td></td></tr> <tr><td>3/8 x 1-1/2"</td><td>25</td><td>8024</td><td></td></tr> <tr><td>3/8 x 1-3/4"</td><td>25</td><td>8025</td><td></td></tr> <tr><td>3/8 x 2"</td><td>25</td><td>8026</td><td></td></tr> <tr><td>3/8 x 2-1/4"</td><td>25</td><td>8027</td><td></td></tr> <tr><td>3/8 x 3"</td><td>25</td><td>8028</td><td></td></tr> <tr><td>3/8 x 3-1/2"</td><td>25</td><td>8029</td><td></td></tr> <tr><td>3/8 x 4"</td><td>25</td><td>8030</td><td></td></tr> </tbody> </table>				Size	PCS	#	PRICE	3/8 x 3/4"	25	8021		3/8 x 1"	25	8022		3/8 x 1-1/4"	25	8023		3/8 x 1-1/2"	25	8024		3/8 x 1-3/4"	25	8025		3/8 x 2"	25	8026		3/8 x 2-1/4"	25	8027		3/8 x 3"	25	8028		3/8 x 3-1/2"	25	8029		3/8 x 4"	25	8030		<p>5/8" U.S.S. (Coarse) Threads Per Inch: 11 S.A.E. (Fine) Threads Per Inch: 18</p> <table border="1"> <thead> <tr> <th>Size</th> <th>PCS</th> <th>#</th> <th>PRICE</th> </tr> </thead> <tbody> <tr><td>5/8 x 1-1/2"</td><td>10</td><td>8049</td><td></td></tr> <tr><td>5/8 x 2"</td><td>10</td><td>8050</td><td></td></tr> <tr><td>5/8 x 2-1/2"</td><td>10</td><td>8051</td><td></td></tr> <tr><td>5/8 x 3"</td><td>10</td><td>8052</td><td></td></tr> <tr><td>5/8 x 3-1/2"</td><td>10</td><td>8053</td><td></td></tr> <tr><td>5/8 x 4"</td><td>10</td><td>8054</td><td></td></tr> <tr><td>5/8 x 5"</td><td>10</td><td>8055</td><td></td></tr> </tbody> </table>				Size	PCS	#	PRICE	5/8 x 1-1/2"	10	8049		5/8 x 2"	10	8050		5/8 x 2-1/2"	10	8051		5/8 x 3"	10	8052		5/8 x 3-1/2"	10	8053		5/8 x 4"	10	8054		5/8 x 5"	10	8055									
Size	PCS	#	PRICE																																																																																								
3/8 x 3/4"	25	8021																																																																																									
3/8 x 1"	25	8022																																																																																									
3/8 x 1-1/4"	25	8023																																																																																									
3/8 x 1-1/2"	25	8024																																																																																									
3/8 x 1-3/4"	25	8025																																																																																									
3/8 x 2"	25	8026																																																																																									
3/8 x 2-1/4"	25	8027																																																																																									
3/8 x 3"	25	8028																																																																																									
3/8 x 3-1/2"	25	8029																																																																																									
3/8 x 4"	25	8030																																																																																									
Size	PCS	#	PRICE																																																																																								
5/8 x 1-1/2"	10	8049																																																																																									
5/8 x 2"	10	8050																																																																																									
5/8 x 2-1/2"	10	8051																																																																																									
5/8 x 3"	10	8052																																																																																									
5/8 x 3-1/2"	10	8053																																																																																									
5/8 x 4"	10	8054																																																																																									
5/8 x 5"	10	8055																																																																																									
				<p>3/4 U.S.S. (Coarse) Threads Per Inch: 10 S.A.E. (Fine) Threads Per Inch: 16</p> <table border="1"> <thead> <tr> <th>Size</th> <th>PCS</th> <th>#</th> <th></th> </tr> </thead> <tbody> <tr><td>3/4 x 2"</td><td>10</td><td>8056</td><td></td></tr> <tr><td>3/4 x 3"</td><td>10</td><td>8057</td><td></td></tr> <tr><td>3/4 x 3-1/2"</td><td>10</td><td>8058</td><td></td></tr> <tr><td>3/4 x 4"</td><td>10</td><td>8059</td><td></td></tr> <tr><td>3/4 x 5"</td><td>10</td><td>8060</td><td></td></tr> </tbody> </table>				Size	PCS	#		3/4 x 2"	10	8056		3/4 x 3"	10	8057		3/4 x 3-1/2"	10	8058		3/4 x 4"	10	8059		3/4 x 5"	10	8060																																																													
Size	PCS	#																																																																																									
3/4 x 2"	10	8056																																																																																									
3/4 x 3"	10	8057																																																																																									
3/4 x 3-1/2"	10	8058																																																																																									
3/4 x 4"	10	8059																																																																																									
3/4 x 5"	10	8060																																																																																									

Peter: 516-455-6331

Mike: 917-435-2648

Fax: 631- 648-9575

Email: XYZFastenersinc@gmail.com

www.xyzfasteners.com

XYZ FASTENERS

Razor Blades 100 PCS



Acid Brushes 3/8" 144PCS



PLASTIC SPREADER

4"
5"
6"



AIR HOSES

Most hoses sold are made of PVC which will coil and become brittle, especially in cold weather.

3/8" hose 1/4" end.

Colors may vary



AMERICAN TAPE

AM 1855 18MM X 54.8MM 48 ROLLO

PG 27 1 1/2 " 24 ROLLO



Peter: 516-455-6331

Mike: 917-435-2648

Fax: 631- 648-9575

Email: XYZFastenersinc@gmail.com

www.xyzfasteners.com

XYZ FASTENERS

**HIGH SPEED PANEL "PUNCH" TWIST DRILLS
HIGHEST QUALITY—US MADE— BRIGHT
APPROX.— 2" OVERALL LENGTH, NON WALKING SPLIT POINT**

DOUBLE END DRILLS



<u>PART #</u>	<u>DECIMAL SIZE</u>	<u>FRACTIONAL EQUIV.</u>	<u>PCS.</u>
BPX-1/8	.125	1/8"	12
BPX-11	.191	3/16"	6
BPX-1/4	.253	1/4"	6

**HIGH SPEED COBALT SPOT WELD DRILLS
IMPROVED DESIGN- MADE IN USA -OVERALL LENGTH-2.25"**



<u>PART #</u>	<u>SIZE</u>	<u>PCS.</u>
SWD-8	8 MM DIAM. DRILL FOR 5/16" SPOT WELD	5
SWD-10	10 MM DIAM. DRILL FOR 3/8" SPOT WELD	5

DRILL FOR ALL

Peter: 516-455-6331

Mike: 917-435-2648

Fax: 631- 648-9575

Email: XYZFastenersinc@gmail.com

www.xyzfasteners.com

**SUPERIOR INSTANT
DOUBLE SIDE TAPE**

PART # WIDTH

SAF990 1/2 “

SAF991 3/16 “

SAF992 7/8 “

SAF993 1/4 “

SAF994 3/4 “

SAF995 1 1/4 “

SAF996 3/8 “

SAF997 2”

SAF998 1”



**Ultra-Bond Plus Tape Adhesion
Promoter**

RS- 999

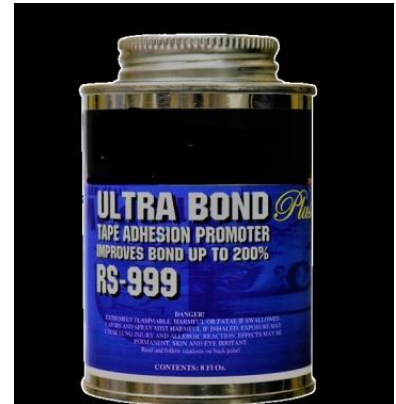

Excellent quality, super fast dry neoprene contact cement for all exterior and interior auto body applications. Quickly reattaches body side moldings, emblems, weatherstrips, and plastic trim parts. Super fast initial cure. Will not harm cured painted surfaces. Light viscosity spreads easily.

RS -135





+1 (516) 455-6331 | WWW.XYZFASTENERS.COM

MIXING TIPS

XYZ Fasteners Inc 776 Marconi Ave, Ronkonkoma, NY 11779



RED TIPS
COMPATIBLES WITH
SEM PRODUCTS



GREEN TIPS
COMPATIBLES WITH CREST
PRODUCTS AND 3M PRODUCTS

NEW ITEMS TO OUR LIST

FOR SPECIAL PRICING
CALL 516-455-6331



BLUE TIPS
COMPATIBLES WITH
JES PRODUCTS 8260 AND
NORTON CARTRIDGE



BLACK TIPS
COMPATIBLES WITH
3M PRODUCT 8194 AND
PLIO-GRIP CARTRIDGE



LONG RED TIPS
COMPATIBLES WITH
FUSOR PRODUCT 401

Peter: 516-455-6331

Mike: 917-435-2648

Fax: 631- 648-9575

Email: XYZFastenersinc@gmail.com

www.xyzfasteners.com

VALUE

SERVICE

QUALITY

FASTENERS

AVAILABILITY

YOUR JOURNEY
our excellence

1

2

3

4

Peter: 516-455-6331

Mike: 917-435-2648

Fax: 631- 648-9575

Email: XYZFastenersinc@gmail.com

www.xyzfasteners.com